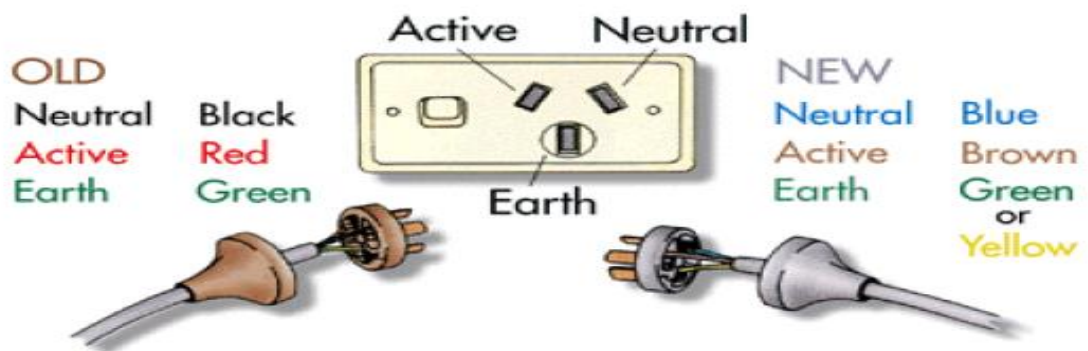


## UNIT – I Wiring Systems and Safety Procedures

### INTRODUCTION

- ☞ Electricity has comprehensively affected our daily life in all spheres.
- ☞ It lights our cities, powers our vehicles, runs machinery in factories, cooks our food, plays our music and gives picture on television.
- ☞ It is difficult to imagine a world without lights, computers, stereos or microwave ovens.
- ☞ It has made life easy and comfortable, but on other side it may cause dangerous situations like shock, electrical accidents and even in some cases may lead to death also.



Electricians have a thorough understanding of electricity.

- They are very familiar with electrical equipment as well as the safety requirements for performing specific tasks.
- To minimize above dangerous situations, Electrician requires a special tool kit as his job involves a lot of occupational hazards.

## Electrical Installation and Estimation (EE3105PE)

---

- Electrician work is a specialized job i.e. he installs, maintains and repairs electrical machinery, equipment and fittings in factories, work- shops, power houses, business and residential premises etc.
- Hence, an electrician always should strive to form safe working habits because safe working habits always save men, money and material.
- Here, an electrician should remember the famous proverb "**Electricity is a good servant, but a bad master**".
- **An 'Electrical installations' means an assembly of associated electrical equipment or machinery placed in a position or connected for use of electricity or to fulfill a specific purpose and having certain co-ordinate characteristics.**
- Installing electrical wiring is an integral part of an electrician's job.
- Working with electrical wiring involves working with devices, accessories, conductors and cables.
- **An 'Estimation' means to determine the quantity of various materials required to execute a job and to assess the cost of the execution.**
- Before taking the work.in hand for execution, it becomes necessary to chalk out a list of quantity of various materials, its cost and labour involved for the completion of the work satisfactorily.

### 2. IMPORTANCE OF ELECTRICAL WIRING

- ☞ Whenever we flip a switch, plug in an appliance, or adjust a reading light, we interact with the electrical system in a house.
- ☞ A good electrician can make those interactions easier in a hundred little ways.
- ☞ Is electrical wiring important?
- ☞ It sounds like an obvious question, but it simply can't be underestimated.
- ☞ Electrical wiring is more than important, it is a vital and necessary part of our life.
- ☞ With wiring, we enjoy lighting for our home, heating and cooling to keep ourselves comfortable, and access to the countless appliances that make our lives better.

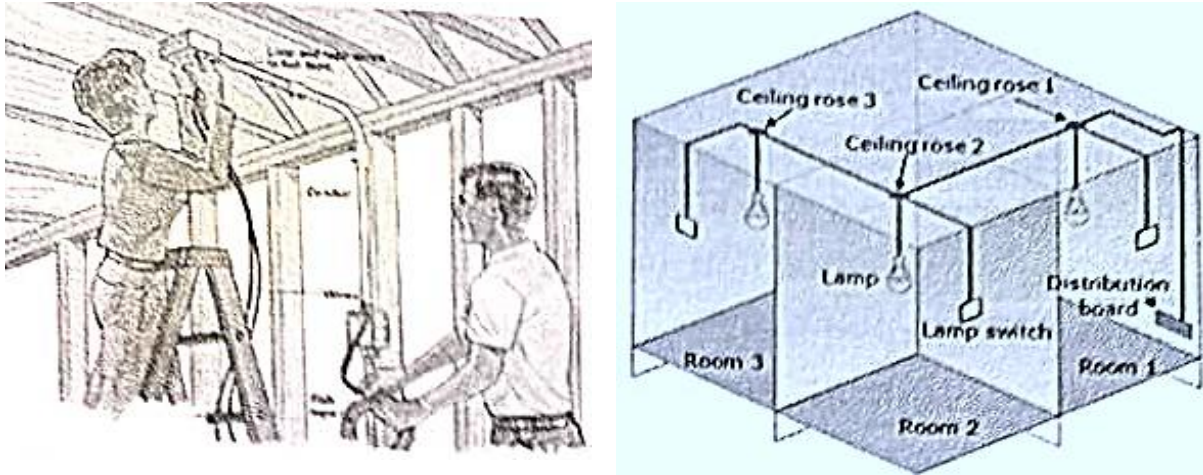


Fig.1.1 Layout of Electrical Wiring

By powering television and computers, it keeps us in touch with the outside world, by powering alarms and security systems, it keeps our homes and our families safe. Without it, we would literally be in the dark.

Electrical systems can appear like a confusing mess of wires, connections and hidden boxes.

If a little care and necessary precautions have been taken, we can easily and safely handle most home wiring projects.

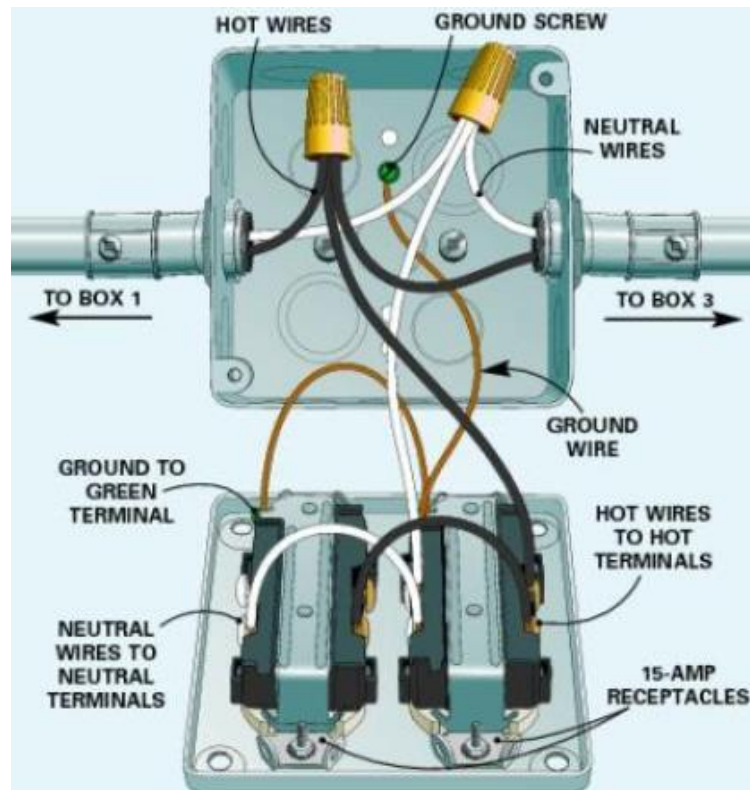
If we learn more about electricity and wiring, we will become more confident.

When wiring is properly installed, an electrical system will provide years of service, but wear and tear always causes problems from time to time.

The real dangers of electric use have been minimized with the use of quality materials like switches, wires and cables etc.

### 2.1. WIRE SPLICING AND TERMINATION

- ☞ The use of conductors and their insulation is regulated by I.E. regulations and I.S. code of practice.
- ☞ Wires and cables are the most common forms of conductors.
- ☞ They carry electric current through all types of circuits and systems.
- ☞ A conductor is a wire or cable or other form of metal, suitable for carrying current from generating station to the point where it is used.
- ☞ All wires are conductors, but all conductors may not wires. For example bus bars in sub-stations are conductors but not wires.



### 2.2. DISTINGUISH BETWEEN WIRE AND CABLE

- ☞ We can define wire and cable according to B.I.S (Bureau of Indian Standards) as follows.
- ☞ **Bare Conductor** : They have no covering. The best example is overhead transmission and distribution lines.
- ☞ **Wire** : If bare conductor is provided with insulation, then it is known as wire. The insulation separates the conductor electrically from other conductors. It allows conductor to be grouped without danger.
- ☞ **Cable** : If two or more insulated conductors are provided inside a single covering, *then it is called Cable*.
- ☞ Cable consists of two or more number of cores insulated separately and there is an overall insulation around the covers.
- ☞ Usually cable are provided with different layers such as metallic sheath, bedding, armouring and serving to protect the cable from moisture, mechanical injury and corrosion.
- ☞ Basically there is no difference between a cable and a wire. It is the relative term.
- ☞ The term "cable" is used for all heavy section insulated conductors, whereas a "wire" means a thin (i.e. smaller) section insulated conductor used for carrying current from one point to another point.



### 2.3.CLASSIFICATION OF WIRES CABLES

∞ The wires/cables used for domestic/industrial wiring are classified into different groups as under.

∞ **1. According to conductor material used**

- ∞ (a) Copper conductor cables.
- ∞ (b) Aluminium conductor cables.

∞ **2. According to number of cores**

- ∞ (a) Single core cable {SCC}.
- ∞ (b) Double core or Twin core cables {DCC}.
- ∞ (c) Three core cables.
- ∞ (d) Four core cables.
- ∞ (e) Two core with earth continuity conductor cable.

∞ **3. According to Voltage grading**

- ∞ (a) Low-Tension (LT) or Low Voltage cables - upto 1000V.
- ∞ (b) High-Tension (H.T) or High Voltage cables :....upto 11kV.
- ∞ (c) Super-Tension (S.T) cables - from 11kV upto 33kV.

## **Electrical Installation and Estimation (EE3105PE)**

---

∞ (d) Extra-High-Tension (E.H.T) cables - from 33kV to 132kV.

∞ (e) Extra-Super-Tension/Voltage cables - beyond 132kV.

### **∞ 4. According to type of insulation**

∞ (a) Vulcanized Indian Rubber (V.I.R) insulated wires/cables.

∞ (b) Tough Rubber Sheathed (T.R.S) or Cab-Tyre Sheathed (C.T.S) cables.

∞ (c) Polyvinyl Chloride (P.V.C) cables.

∞ (d) Lead Sheathed cables.

∞ (e) Weather Proof cables.

∞ (f) Flexible cords and cable.

### **∞ 5. According to the construction**

∞ (a) Belted cable

∞ (b) H-type cables (designed by H.Hochstader)

∞ (c) S.L (separate Lead) type cables.

∞ (d) H.S.L type cables (combination of H-type and S.L type cables).

### **∞ 6. According to type of wires used for winding of machines**

∞ (a) Single cotton covered (SCC)

∞ (b) Double Cotton Covered(DCC)

∞ (c) Enamel coated wires

### **∞ 7. According to use of dielectrics to withstand electrical stress**

∞ (a) Oil filled cables

∞ (b) Gas Pressure cables.

∞ Internal Pressure Cables

∞ External Pressure Cables

### **1. According to conductor material used:**

∞ The function of conductor is to carry electrical current.

∞ In electrical work, in both power and lighting cables the conductors are made with Copper or Aluminium.

∞ **i) Copper conductor cables:**



## Electrical Installation and Estimation (EE3105PE)

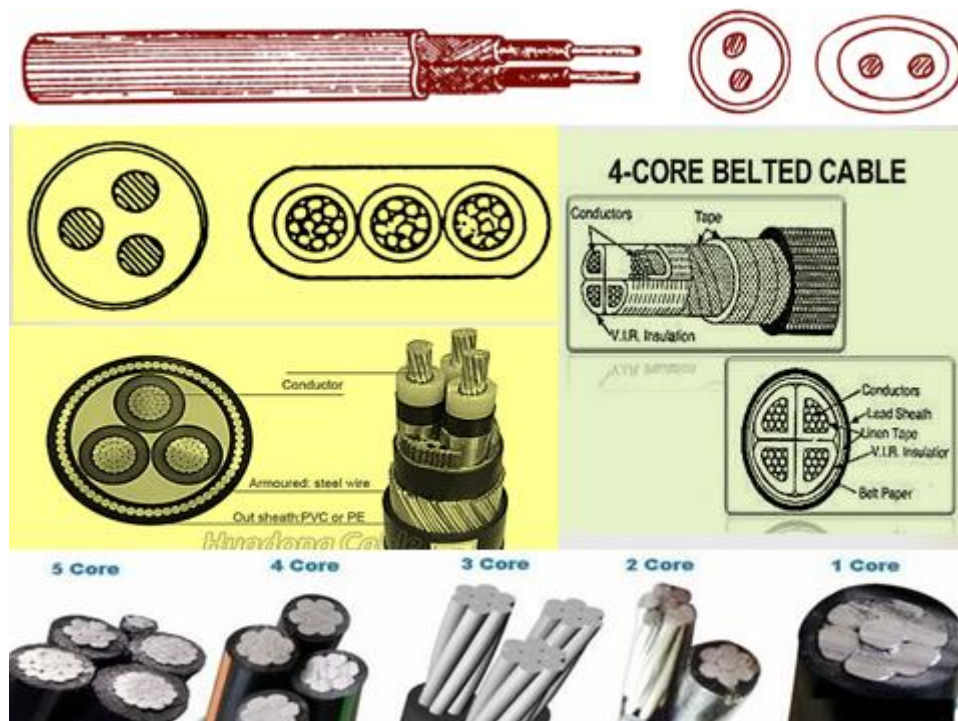
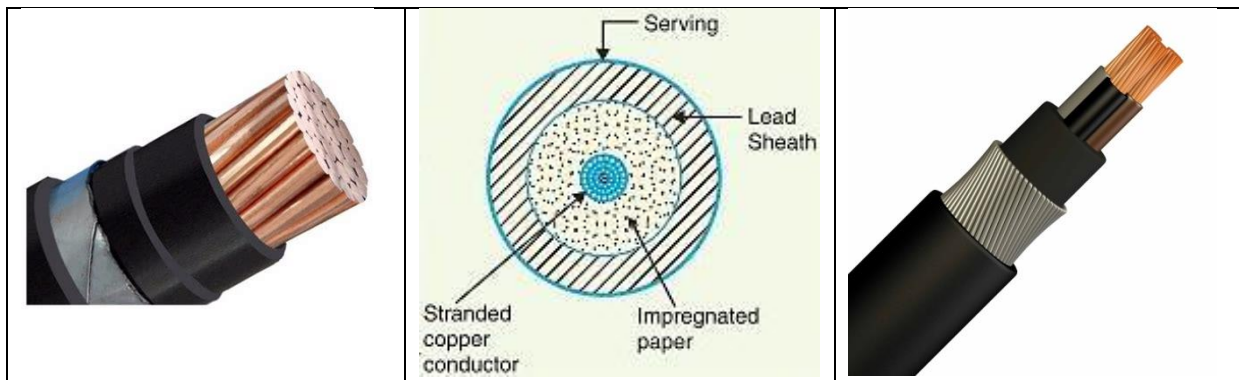
- ⌘ Though silver is better conductor than copper, due to its high cost it is rarely used.
- ⌘ Copper is cheaper than silver and conductivity next to silver.
- ⌘ **The copper used should have a very high degree of purity, say 99.9%, such a copper has a resistivity of  $1.786 \times 10^{-8}$  W-m at 200c.**
- ⌘ It is mechanically strong, hard, durable and ductile.
- ⌘ It has a high resistance to atmosphere corrosion and oxidation, hence can serve for long time.
- ⌘ It can be easily soldered, welded and can be drawn into thin wires and sheets.
- ⌘ It has larger current density, hence requires less volume to carry current.
  
- ⌘ Copper conductors may be annealed or hard drawn.
- ⌘ Annealed copper conductors are soft and suitable for indoor and outdoor wires/cables, whereas hard drawn copper conductors have high tensile strength and used as overhead conductors.
- ⌘ However, due to its high cost and non-availability, it is rarely used as overhead conductors.
- ⌘ **ii) Aluminium conductor cables:**
- ⌘ Aluminium has good conductivity, next to copper.
- ⌘ **The conductivity of aluminium is 60.6% of that of copper.**
- ⌘ **The resistivity of aluminium is  $2.87 \times 10^{-8}$  W-m at 200c.**
- ⌘ **For the same resistance and length aluminium required will be 1.61 times that of copper in volume and 1.26 times that of copper in diameter.**
- ⌘ It is cheaper and lighter in weight than copper.
- ⌘ It can be drawn into thin wires and sheets, but it loses its tensile strength.
- ⌘ In order to increase the tensile strength, the aluminium conductors are reinforced with a core of galvanized steel and such a conductor are known as Aluminium Conductor Reinforced and is abbreviated as A.C.S.R which is extensively used for overhead transmission and distribution lines.



### 2. According to number of cores:

- ☞ All cables have one or more number of central cores.
- ☞ Depending on number of cores the cable are classified as;
- ☞ **i) Single-Core Cable (SCC):**

- ☞ It consists only one core of tinned stranded copper (or aluminium) insulated by layers of impregnated paper.
- ☞ The advantages of single-core cable are simple in construction and availability of large cross section.



- ☞ **ii) Double-Core Cable or Twin-Core Cable:**
- ☞ This cable consists of two copper (or aluminium) cores.



## Electrical Installation and Estimation (EE3105PE)

---

- ☞ Each core is insulated separately and there is an overall insulation around the cores.
- ☞ This is again provided with different layers to protect from various injuries as shown.

### ☞ **iii) Three-Core Cable:**

- ☞ It consists of three cores of stranded copper (or aluminium) and each core is insulated from each other by layers of impregnated paper.
- ☞ Another layer of impregnated paper tape is wound around three cores.
- ☞ The cable may be provided with lead sheath to protect the cable from moisture and mechanical injury.
- ☞ This is mainly used for 3- phase service.

### ☞ **iv) Four-core Cable:**

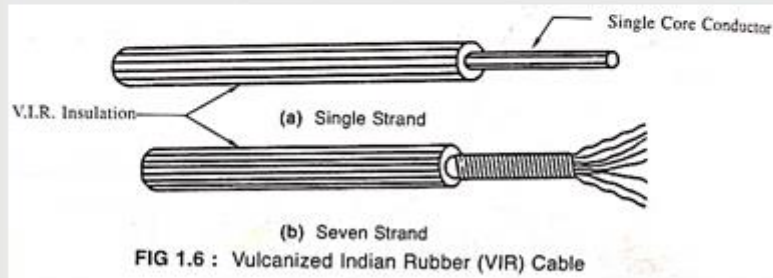
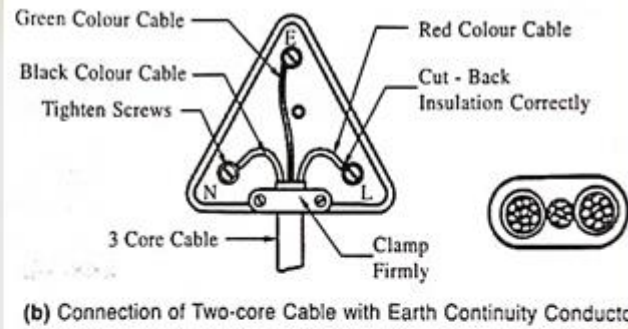
- ☞ Its construction is similar to three core cable and is used for 3-phase, 4-wire supply system.

### **3. According to type of insulation:**

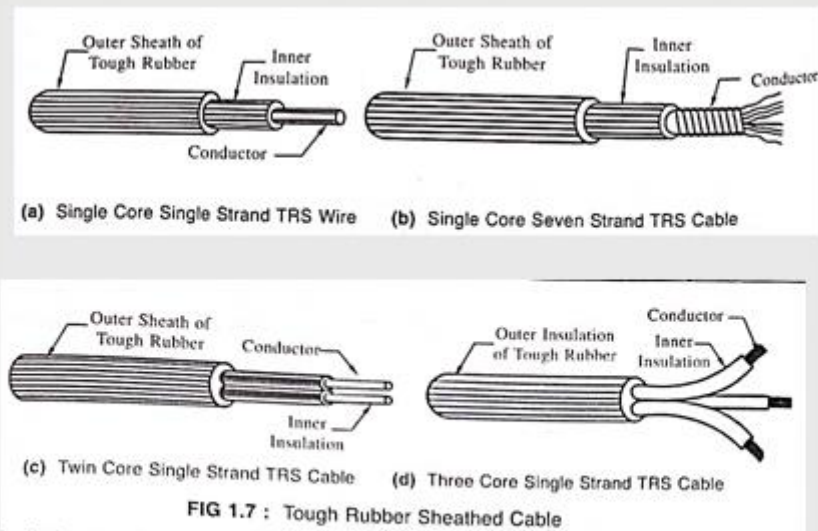
- ☞ The satisfactory operation of a cable depends to a large extent on the characteristics of insulation used.
- ☞ Therefore selecting a proper insulating material for a particular job is most important.
- ☞ The following are the classification of cables depending upon insulation used.

### ☞ **i) Vulcanized Indian Rubber (VIR) Cables:**

- ☞ This type of wires/cables is generally used in casing-capping, cleat wiring, conduit wiring and for general electrical wiring etc.
- ☞ These are available in two different grades i.e. 250V and 600V.
- ☞ It consists of tinned copper conductor (or aluminium) with a layer of Vulcanized Indian Rubber insulation as shown in fig.
- ☞ The copper conductor is tinned to provide protection against corrosion due to presence of sulphur, zinc oxide and other mineral ingredients in the VIR.



Dr.K.Eswaramoorthy



Dr.K.Eswaramoorthy



Over the rubber insulation cotton tape sheathed covering, with moisture resistant compound is provided.

Finally it is finished with wax to protect the wires from damages while drawing through the conduit pipe.

These are available in different sizes as 1/18, 3/20, 3/22, 7/20, 7/22, 7/16, 19/18, 19,16 S.W.G. etc. (numerator represents number of strands and denominator represents gauge number of each strand).

They are available in different colours such as white, black and brown.

### **ii) Tough Rubber Sheathed (TRS) or Cab Tyre Sheathed (CTS) Cables:**

These cables are generally used in batten wiring (TRS or CTS wiring).

These are available in 260/440 volt and 650/1100 volt grades and they may be single core or twin core as shown in fig.

It has a tinned copper conductor or aluminium conductor covered with Vulcanized Rubber.

Over the Vulcanized rubber, it is provided with Tough rubber, hence the name Tough Rubber Sheathed cable.

The Tough Rubber provides protection to the cable against wear and tear.

These are cheap and light in weight.

These are available in different sizes such as 1/18, 3/22, 3/20, 7/22 S.W.G. etc.

### iii) Polyvinyl chloride (PVC) cables:

- ☞ These cables are used in industrial and domestic wiring such as batten wiring, casing and capping wiring, conduit pipe wiring etc.
- ☞ These are available in 250/440 volt and 650/1100 volt grades and may be single core, double core, three core and three and half core for different applications as shown in fig.
- ☞ It consists of a tinned copper conductor or aluminium conductor may be single core or multi strands, covered with P.V.C. As PVC is harder than rubber, PVC cables do not require cotton tape against mechanical and moisture protection.
- ☞ The PVC insulation does not create any chemical reaction with the metal of the wire/cable.
- ☞ P.V.C. insulation has more life and good appearance.
- ☞ These cables are available in different sizes such as 1/18, 3/22, 3/20, 7/22, 7/20 S.W.G. etc. and available in various colours like white, black, red, yellow, blue etc.



☞

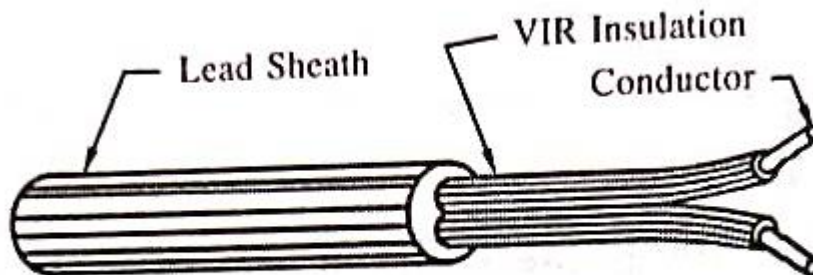
### sheathed cables:

- ☞ These cables are used where the climate condition is wet and has a little bit of moisture.

iv) Lead

## Electrical Installation and Estimation (EE3105PE)

- ☞ These cables consist of a tinned copper conductor or aluminium conductor, covered with rubber insulation, and then covered with a continuous sheath of lead.
- ☞ The lead provides protection to the cable against moisture as well as mechanical injury.
- ☞ These cables are fire proof and weather proof and not affected by chemical and fumes.
- ☞ They are available in different sizes like 1/18, 3/20 S.W.G. and even in single core, double core, two core with earth continuity conductor etc.

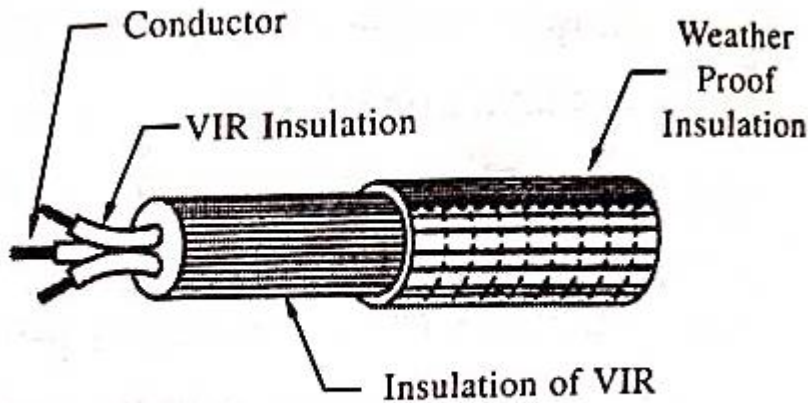


**FIG 1.9 : 2- Core Lead Sheathed Cable**

### ☞ v) Weather proof cables:

- ☞ These cables are generally used for outdoor applications i.e. where the wires are exposed to sunlight, rain etc.
- ☞ It is generally used in service lines and are available in 250 and 600 grades.
- ☞ These cables consists of tinned copper or aluminium conductors cover with a layer of VIR or PVC insulation.
- ☞ This insulation is covered with cotton tape braided and weather proof compounds as shown in fig.
- ☞ They are available indifferent sizes like 1/18, 3/20, 3/22, 7/20 S.W.G. and so on.

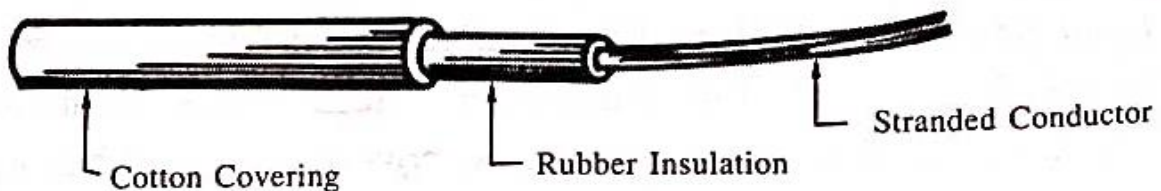




**FIG 1.10 : 3 - Core Weather Proof Cable**

❧ **vi) Flexible cords and cables:**

- ❧ These are used for connecting wires for such purposes as from ceiling rose to lamp holders, socket outlets to household appliances like electric heater, table lamp, fans, refrigerators, T.V etc.
- ❧ These wires are required to be durable and flexible.
- ❧ Flexibility is obtained by using conductors with more number of strands.
- ❧ If they are not flexible it may crack and break very soon.
- ❧ These cables have tinned copper conductors.
- ❧ They are available in different sizes like 14/0.9976, 40/0.0076, 162/0.0076, which means that there are 14, 40 or 162 strands of copper wires each having a diameter of 0.0076 inch which is equivalent to 36 S.W.G.



**FIG 1.11 : Flexible Cords and Cables**

**3.Use of Cables**

- ❧ Electric Power can be transmitted and distributed either by OH conductors or underground cables (LV,HV, EHV)
- ❧ UG cables are used where its difficult to erect OH lines and use of impractical.

## Electrical Installation and Estimation (EE3105PE)

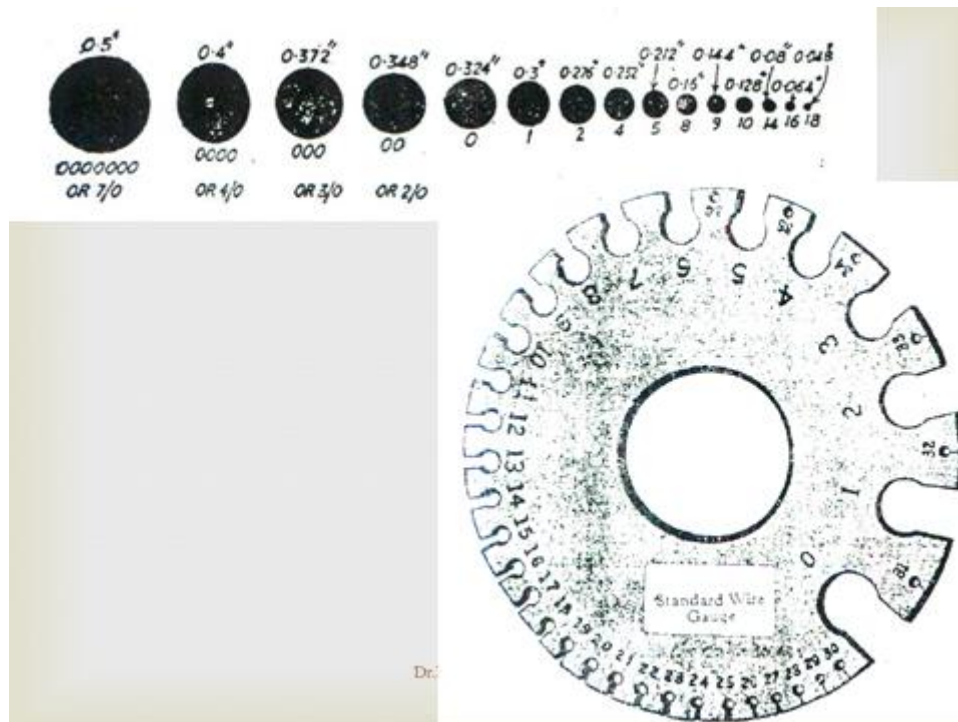
---

- ⌘ Eg: Congested urban areas, thickly populated areas where municipal authorities prohibited OH lines for reasons safety, general appearance or around plants and substances or where maintenance conditions do not permit the use of OH lines.
- ⌘ The type cable used will be depends on the voltage and service requirements.
- ⌘ Cables used only for congested urban areas at comparatively low and medium voltages.
- ⌘ Development in design of cables, distribute the power at high voltages and transmit power for short distances.

### 4. Standard Wire Gauge

- ⌘ The Standard Wire Gauge (S.W.G) is a device, which is used for determining the size of a wire in terms of gauge number.
- ⌘ The wire gauge commonly used in India is the British Standard Wire Gauge.
- ⌘ It is a thin circular plate of steel, with a number of slots on its circumference as shown in fig.
- ⌘ The slots are made of different sizes and the numbers are marked on each slot in a systematic way.
- ⌘ Holes are provided at the end of each slot for removing the wires easily.
- ⌘ To find the gauge of a wire, insert the wire in each slot and find a particular slot into which a bare wire just slides without being damaged.
- ⌘ The number marked opposite to the slot is number of the gauge required.
- ⌘ The largest wire gauge number is 00,00,000 (named as seven zero) or simply written as 7/0 having a diameter of 12.70mm, whereas the smallest number of wire is 40 having a diameter of 0.1219mm.
- ⌘ It can be observed that the higher the number of wire gauge, the smaller is the diameter and vice-versa.
- ⌘ Table 1.1 gives the diameters and area of cross-section for corresponding gauge numbers of the British Standard Wire Gauge.

## Electrical Installation and Estimation (EE3105PE)



Gauge Number	Diameter in mm	Area in mm <sup>2</sup>
7/0	12.7000	126.6769
6/0	11.7856	109.0921
5/0	10.9728	94.5638
4/0	10.1600	81.0732
3/0	9.4488	70.1202
2/0	8.8392	61.3643
0	8.2296	53.1921
1	7.62	45.6037
2	7.0104	38.5990
3	6.4008	32.1780
4	5.5928	24.5668
5	5.3848	22.7735

Gauge Number	Diameter in mm	Area in mm <sup>2</sup>
6	4.8768	18.6793
7	4.4704	15.6958
8	4.064	12.9717
9	3.6576	10.5071
10	3.2512	8.3019
11	2.9464	6.8183
12	2.6416	5.4805
13	2.3368	4.2888
14	2.032	3.2429
15	1.8288	2.6268
16	1.6526	2.1450
17	1.4224	1.5890
18	1.2192	1.1675
19	1.016	0.8107
20	0.9144	0.6567

Gauge Number	Diameter in mm	Area in mm <sup>2</sup>	Gauge Number	Diameter in mm	Area in mm <sup>2</sup>
21	0.8128	0.5189	31	0.2946	0.0682
22	0.7112	0.3973	32	0.2743	0.0591
23	0.6096	0.2919	33	0.254	0.0507
24	0.5588	0.2452	34	0.2337	0.0429
25	0.508	0.2027	35	0.2134	0.0358
26	0.4572	0.1642	36	0.193	0.0293
27	0.4166	0.1363	37	0.1727	0.0234
28	0.3759	0.1110	38	0.1524	0.018241
29	0.3454	0.0937	39	0.1321	0.013701
30	0.315	0.0779	40	0.1219	0.011675

### 4.1 Specifications of Cables

- ☞ The cables are specified in number of ways such as type of conductor material, number of cores that the cable consists, voltage grading etc. Cables may be specified as follows.
- ☞ 7/20,VIR, Aluminium conductor, twin core, 650/1100 grade.
  - ❖ The numerator '7' indicates number of strands in a cable and denominator 20 represents the gauge number of each strand. The cable has two cores made with Aluminium, with VIR insulation and is used for 650/1100 voltage.
- ☞ 19/1.12, Aluminium conductor, 3 1/2 core, 1100V, PVC cable, PVC sheathed.
  - ❖ In this case the cable consists of '19' strands, each strand have a diameter of 1.12 mm. The conductor is made with Aluminium, insulation is made with PVC, is covered with PVC sheathing, and is used for 1100 V supply system.

### 4.2 STRANDED CABLE

- ☞ The solid conductor cable consists of only one conductor, whereas stranded conductor cable consists of number of strands of wires of circular cross-section.
- ☞ Stranded conductor cable is more flexible than solid conductor cable and becomes easy to handle.
- ☞ Stranding is done .by twisting the wires of different layers in opposite direction for successive layers.

## Electrical Installation and Estimation (EE3105PE)

- ☞ The number of strands in stranded cables are 3, 7, 19, 37, 61, 91 and so on, which can be determined from the formula  $1 + 3n(1 + n)$ , where 'n' is number of the layers.
- ☞ In a three-strand cable, two strands are twisted around the third strand. Similarly, in case of seven or more strands the arrangement of the conductors is as below.
- ☞ **7 Strands** : Six strands are twisted around a central strand.
- ☞ **19 Strands** : Seven strands are twisted as above and the remaining 12 strands are twisted in opposite direction to that of previous layer.
- ☞ **37 Strands** : Nineteen strands as above and the remaining 18 strands are twisted in opposite direction to that of previous layer.

### 5. Size and Current Carrying Capacity of a Wire / Cable

- ☞ The size of the wire or cable should be such that, it should carry the maximum circuit current continuously without overheating.
- ☞ From Table.1.2 and Table.1.3 the size of wire or cable can be determined for corresponding current carrying capacity.
- ☞ In domestic wiring, the wire or cable used must not be of size less than 1/1.1 2 mm ( $1.0\text{mm}^2$ ) Copper or 1/1.4 mm ( $1.5\text{mm}^2$ ) in Aluminium wire.

**TABLE 1.2: Current Carrying Capacity of Copper Conductor, PVC Insulated Cable**

Sl.No	Size of the cable			Current rating at 40°C in ampere	
	Number & diameter of wire in mm	No. & size of equivalent S.W.G	Nominal cross-sectional area in $\text{mm}^2$	2-core cable	3 or 4 cable
1	1/1.12	1/18	1.00	5	5
2	3/0.736	3/22	1.29	10	10
3	3/0.915	3/20	1.93	15	13
4	7/0.736	7/22	2.90	20	15
5	7/0.915	7/20	4.52	28	22
6	7/1.12	7/18	6.45	36	29
7	7/1.32	7/17	9.35	43	34
8	7/1.626	7/16	14.50	53	42
9	19/1.12	19/18	19.35	62	50
10	19/1.32	19/17	25.80	74	59
11	19/1.626	19/14	38.70	97	78

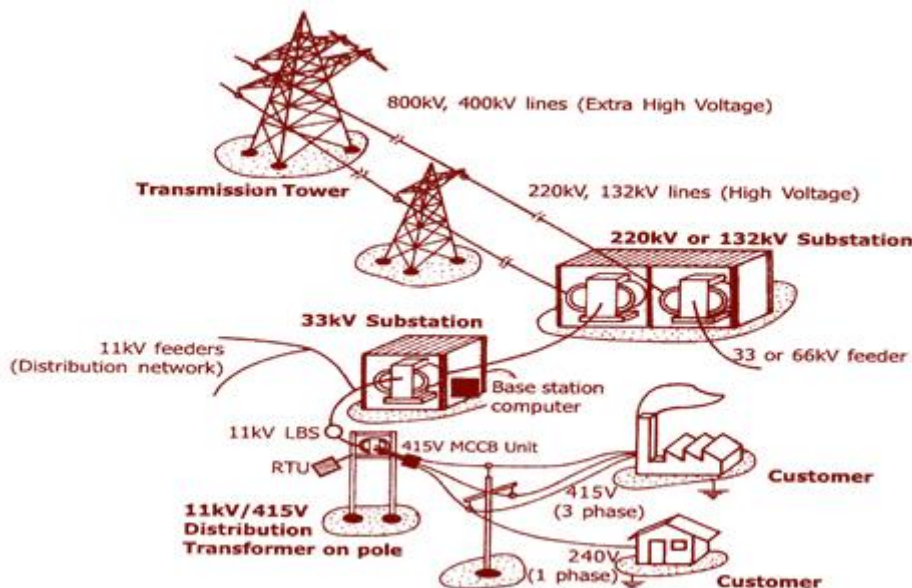


**TABLE 1.3: Current Carrying Capacity of Aluminium Conductor, PVC Insulated Cable and PVC sheathed cable.**

Sl.No	Size of the cable			Current rating at 40°C in ampere	
	Number & diameter of wire in mm	No. & size of equivalent S.W.G	Nominal cross-sectional area in mm <sup>2</sup>	2-core cable	3 or 4 cable
1	1/1.40	3/22	1.5	10	9
2	1/1.80	3/20	2.5	15	11
3	1/2.24	7/22	4.0	20	15
4	1/2.80	7/20	6.0	27	21
5	1/3.55	7/18	10.0	34	27
6	7/1.70	7/17	16.0	43	35
7	7/2.24	19/18	25.0	59	48
8	7/2.50	19/17	35.0	60	55
9	7/3.00	19/16	50.0	91	69

### 5.1 Wiring Systems

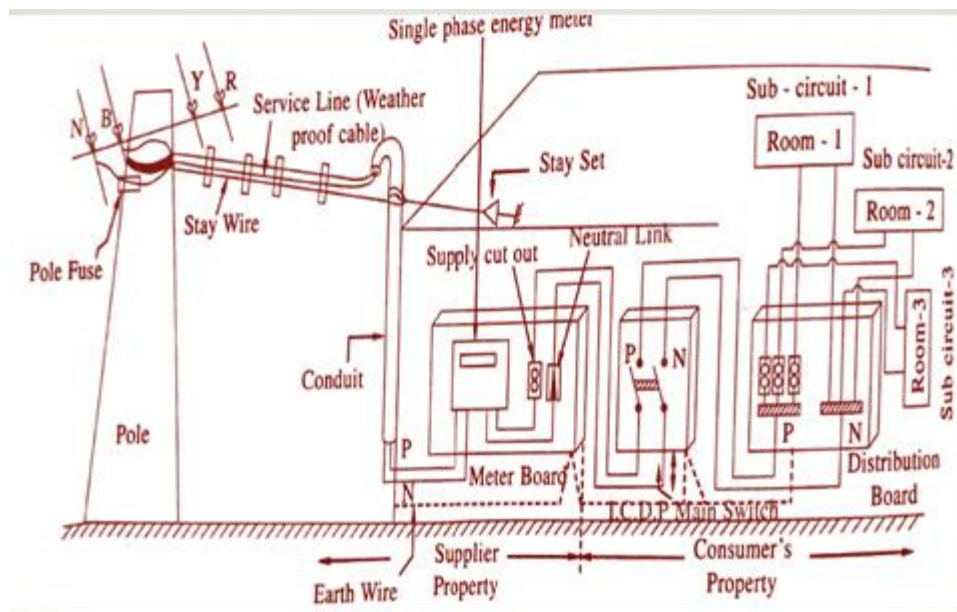
### 5.2 HOW ELECTRIC SUPPLY COMES TO OUR HOUSE



- ☞ Power is carried through a transmission network of high voltage lines.
- ☞ Usually, these lines run into hundreds of kilometres and deliver the power into a common power pool called the grid.
- ☞ The grid is connected to load centres (cities) through a sub-transmission network of normally 33kV (or sometimes 66kV) lines.

## Electrical Installation and Estimation (EE3105PE)

- ☞ These lines terminate into a 33kV (or 66kV) substation, where the voltage is stepped-down to 11kV for power distribution to load points through a distribution network of lines at 11kV and lower.
- ☞ The power network, which generally concerns the common man, is the distribution network of 11kV lines or feeders downstream of the 33kV substation.
- ☞ Each 11kV feeder which emanates from the 33kV substation branches further into several subsidiary 11kV feeders to carry power close to the load points (localities, industrial areas, villages, etc.,).
- ☞ At these load points, a transformer further reduces the voltage from 11kV to 415V to provide the last-mile connection through 415V feeders (also called as Low Tension (LT) feeders) to individual customers, either at 240V (as single phase supply) or at 415V (as three-phase supply).
- ☞ A feeder could be either an overhead line or an underground cable. In urban areas, owing to the density of customers, the length of an 11kV feeder is generally up to 3 km.
- ☞ On the other hand, in rural areas, the feeder length is much larger (up to 20 km). A 415V feeder should normally be restricted to about 0.5-1.0 km.
- ☞ Unduly long feeders lead to low voltage at the consumer end.



- ☞ The supply is taken from the distribution line through service mains either by overhead line or underground cable.
- ☞ A pole fuse may be provided to protect the service line against over loading.
- ☞ The supply is directly fed to the energy meter and after energy meter a service fuse (Iron clad cutout) is provided for safety purpose.

## Electrical Installation and Estimation (EE3105PE)

---

- ☞ Both energy meter and Iron clad cutout are supplied by the supply authority (State Electricity Board), hence both are sealed by supplier.
- ☞ The mains (phase and neutral) are taken from the energy meter and are controlled by means of neutral linked Iron Clad Double Pole (I.C.D.P) main switch.
- ☞ After passing through the ICDP, the wires go to distribution board.
- ☞ From distribution board, the power is distributed to various sub-circuits.
- ☞ Separate phase and neutral is taken for each sub-circuit.
- ☞ According to Indian Standards the maximum number of points of lights, fans, and 5A socket outlets that can be connected in one sub-circuit is 10 and the maximum load that can be connected in each sub-circuit is 800 watts.
- ☞ The earth wire is connected to the all metallic parts of the wiring and appliances except the current carrying conductors.
- ☞ Now-a-days instead of fuse, Miniature circuit breakers (MCB's) are used and instead of ICDP automatic isolators are used.

### 5.3 CHOICE OF WIRING SYSTEM

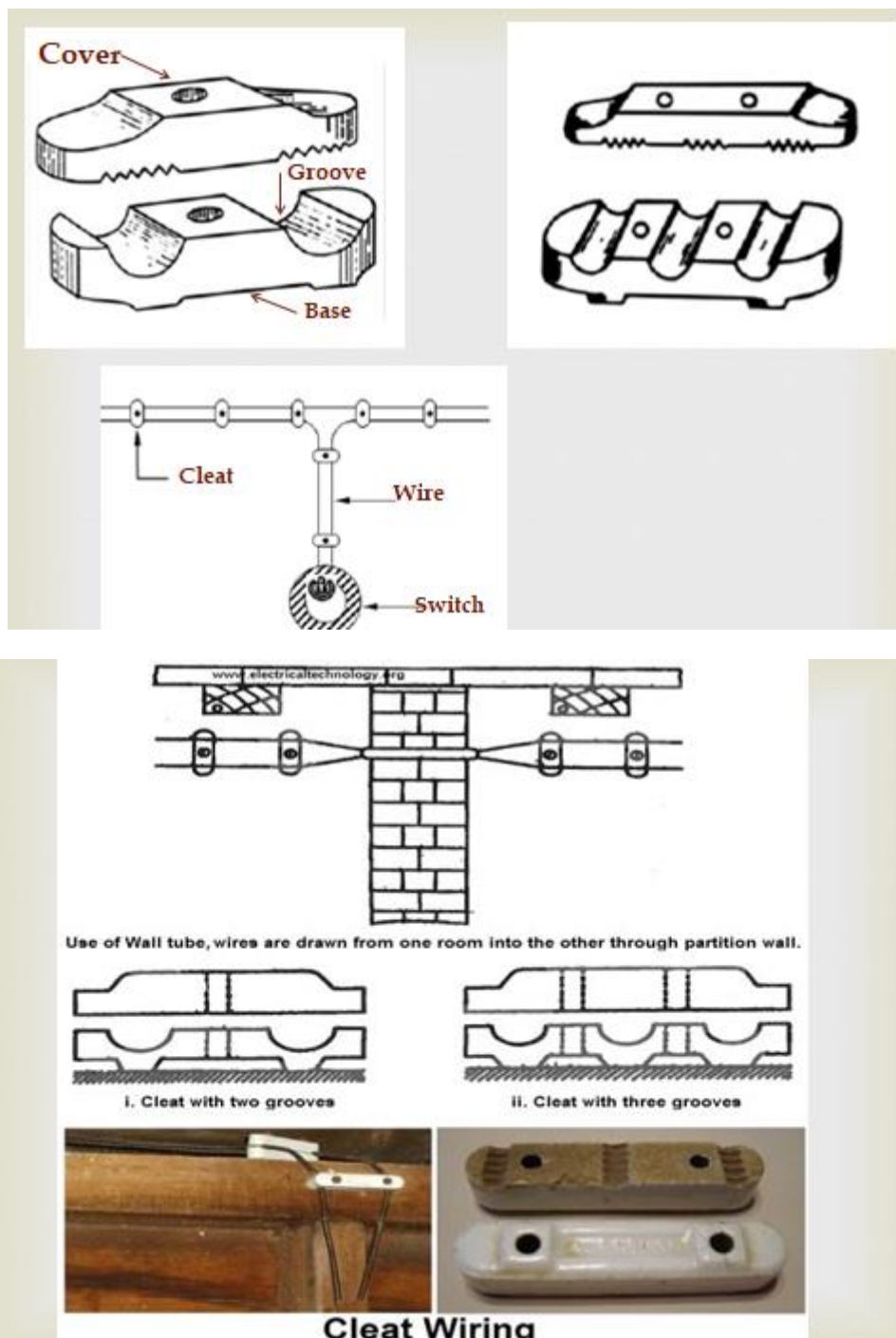
- ☞ The choice of any wiring system for a particular place depends on many factors. Hence, following points should be considered before selecting the type of wiring system.
- ☞ **i) Durability:** The wires used in any wiring must be durable and should be safe from fire and weather conditions etc.
- ☞ **ii) Safety:** The wiring selected should not be risky to any human being.
- ☞ **iii) Cost:** This is most important factor. The wiring selected should be economical.
- ☞ **iv) Appearance:** The wiring must provide good outlook after its installation and it should be according to the construction and design of the building.
- ☞ **v) Accessibility:** The selected wiring should be easily accessible and easy to extend.
- ☞ **vi) Mechanical protection:** The selected wiring system should provide enough mechanical protection during its use

### 6. SYSTEMS OF WIRING

- ☞ The various systems of wiring used in our country are:

1. Cleat wiring.

2. Wooden casing and capping wiring.
3. C.T.S. or T.R.S. wiring.
4. Lead sheathed or Metal sheathed wiring.
5. Conduit wiring.
  - a) Surface or open type
  - b) Recessed or concealed type



### ❖ Advantages:-

- ☞ It is cheapest system of wiring.
- ☞ It requires less labour and workman ship.
- ☞ It requires less time for installation and less cost.
- ☞ It can be easily and quickly removed when not required.
- ☞ Extension and fault location is easy.

### ❖ Disadvantages:-

- ☞ It is quite temporary system of wiring.
- ☞ Less life and less efficiency.
- ☞ Dust and dirt spoil the appearance.
- ☞ The wires are exposed to mechanical injury.
- ☞ The oil, dust and smoke injure the wires.

### ❖ Applications:

- ☞ It is used for purely temporary purpose like camps etc.
- ☞ It is not suitable in damp places, blacksmith shops etc.
- ☞ It is preferred where appearance is not so important and cost is main consideration.

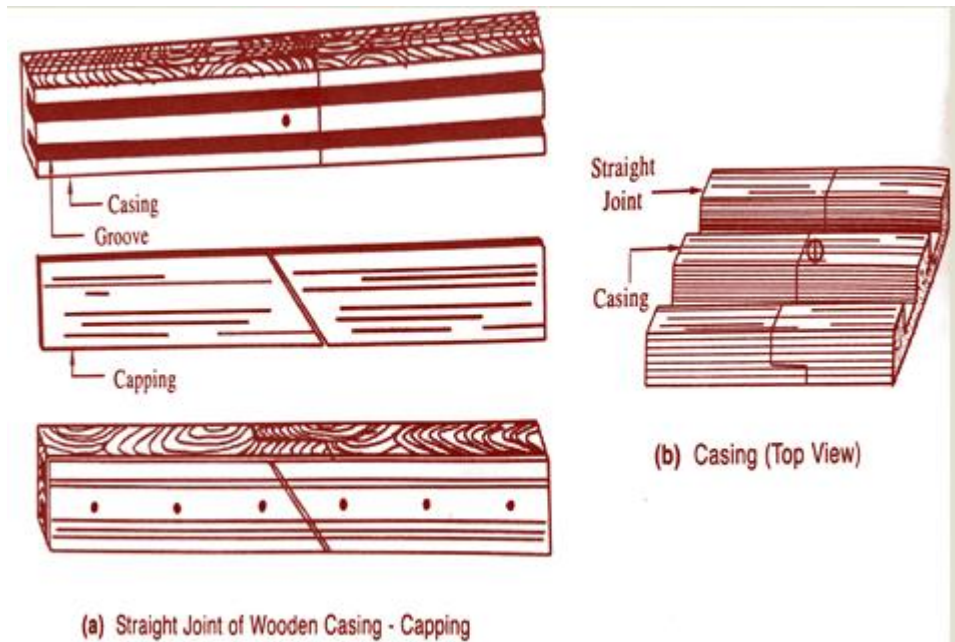
## 6.2. Wooden Casing and Capping Wiring

- ☞ This system was introduced 60 years ago, when it was first considered necessary to provide some protection to cables.
- ☞ The cables used in this system are either VIR or PVC insulated cables.
- ☞ It consists of **rectangular wooden blocks made from quality seasoned teak wood or any other quality wood called casing.**
- ☞ The casing **consists of V shaped grooves** into which the wires are laid.
- ☞ The casing is first fixed on the surface of the wall or ceiling by means of wooden gutties and screws.
- ☞ The **casing then covered at the top by means of rectangular strip of wood known as capping of same width as that of casing and is screwed to it.**



## Electrical Installation and Estimation (EE3105PE)

- ☞ The casing and capping are available in different sizes and the length in which these available varies form 2.5 meters to 3 meters.



### Advantages:-

- ☞ This wiring has good appearance.
- ☞ The life is more compared to cleat wiring.
- ☞ Easy for installation and rewire.
- ☞ The wires are safe from mechanical damage, rats etc.
- ☞ Easy to inspect by opening capping.

### Disadvantages:-

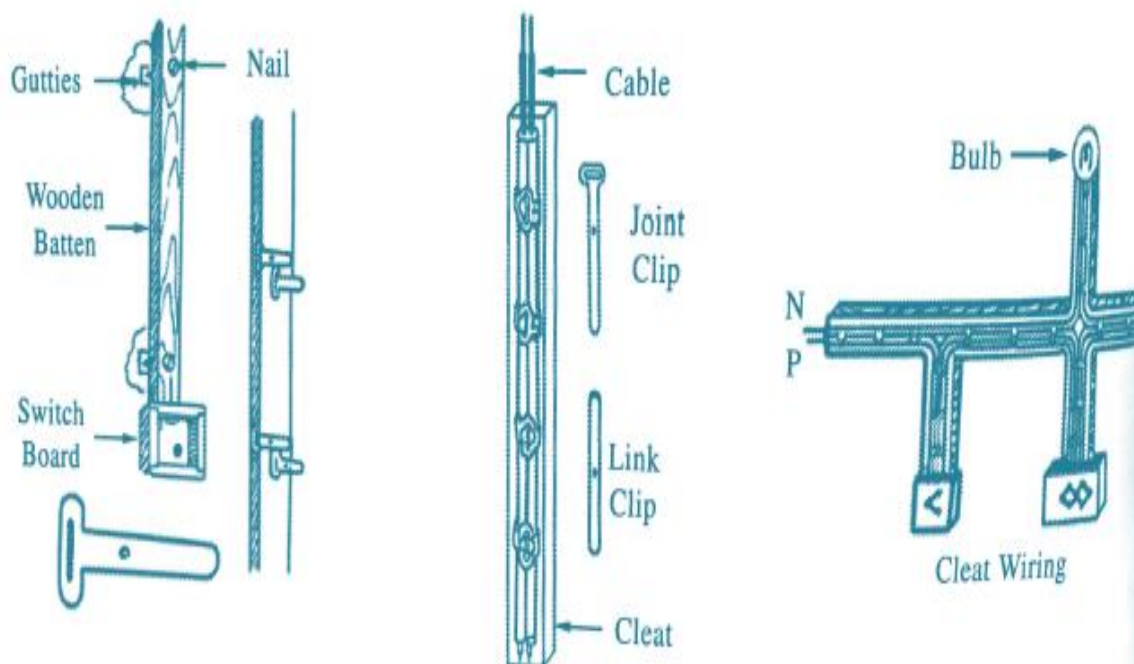
- ☞ No safety from fire.
- ☞ It requires better workman ship, so labour cost is high.
- ☞ Can not be used in damp places.
- ☞ If not painted and varnished, the vermins may eat the wood, which reduces the life of the system.

### Applications: -

- ☞ This system is suitable for low voltage domestic installations in dry places.
- ☞ It should never be used where there is a risk of fire such as blacksmith moulding shops etc. and in damp places.

### 6.3. Tough Rubber Sheathed (T.R.S.) or Cab Tyre Sheathed batten wiring

- ☞ **The wires used in this system are T.R.S. or C.T.S. wires, which are available in single core, twin core or three core with a circular or oval shape.**
- ☞ These cables are quite flexible and the insulation can resist moisture, chemical, water, steam, but slightly affected by lubricating oils.
- ☞ In this system, first wooden battens are secured to the walls or ceiling by means of wooden screws and wooden gutties.
- ☞ The wires are fixed on wooden batten with the help of tinned brass link clips already fixed on the batten with brass pins and spaced at an interval of 10 to 15 cm as shown in fig.
- ☞ The wooden battens are made with seasoned teak wood and are available in different sizes according to the width and thickness.
- ☞ The width are 13, 19, 25, 31, 38, 44, 50, 63, 69 and 75 mm, the thickness may be 10mm at least.
- ☞ The link clips are available length-wise 16mm, 25mm, 30mm, 40mm, 50mm, 80mm etc.



#### Advantages:-

- ☞ Its installation is easy, semi-skilled worker can do it, so labour cost is less.
- ☞ It is less costly than wooden casing and capping wiring.
- ☞ It has good appearance.

## Electrical Installation and Estimation (EE3105PE)

---

- ☞ Its life is sufficiently long.
- ☞ It can withstand against chemicals such as acids and alkalis.

### Disadvantages:-

- ☞ There is no safety from fire.
- ☞ It is not suitable in places, where it is exposed to sun and rain.

### Applications:-

- ☞ This wiring is suitable for low voltage installations used for lighting purpose in all places such as domestic, industrial, commercial etc.
- ☞ As T.R.S. wire is not affected by moisture, can be used in damp places also.

### 6.4. Lead Sheathed or Metal Sheathed wiring

- ☞ **This type of wiring consists of T.R.S. or P.V.C. insulated wires with an outer covering of lead aluminium alloy containing about 95% of lead.**
- ☞ This metal sheath provides protection to the cable against mechanical injury and atmosphere conditions.
- ☞ The cables are fixed by means of the link clips on wooden batten.
- ☞ The lead sheath must be earthed, at a point of entry to protect against electrolytic action due to leakage current.

### Advantages:-

- ☞ The wires are safe from fire, moisture and mechanical damages.
- ☞ It is easy for installation and looks nice.
- ☞ It has long life.
- ☞ It can be used in places even which are exposed to sun and rains also.
- ☞ It has good appearance.

### Disadvantages:-

- ☞ It is costlier than T.R.S. wiring because of lead covering.
- ☞ It is not suitable for places where chemical corrosion may occur.
- ☞ Skilled worker required, so the labour is costly.

### Applications:-

## Electrical Installation and Estimation (EE3105PE)

---

- ☞ It is suitable for low voltages (250V) installations. It may be used in places exposed to sun and rain.
- ☞ When wooden battens are not available wires can be fixed directly on walls.

### 6. 5. Conduit wiring

- ☞ In general conduit means tube or channel. Tubular conduits are most commonly used in electrical installations.
- ☞ When wires/cables are drawn through the conduit and terminated at the outlets (switches, holders, ceiling rose etc.), such a system of wiring is known as conduit wiring.
- ☞ **There are four types of conduits, which are commonly used. They are**
  - ☞ **1 Rigid steel (metal) conduits.**
  - ☞ **2 Flexible steel conduits.**
  - ☞ **3 Rigid P.V.C. (non-metallic) conduits.**
  - ☞ **4 Flexible P.V.C. conduits.**
- ☞ The conduits are electrically and mechanically continuous. The conduits are available in lengths of 3.00 meters and in diameters from 12mm to 65mm.
- ☞ The different sizes of conduits are 12mm, 19mm, 25mm, 32mm, 38mm, 50mm and 65mm etc.
- ☞ Conduit wirings are two types.
- ☞ **i) Surface conduit wiring:**
  - ☞ **In this system conduits are fixed on the surface of the walls or ceiling by means of the saddles, secured to wooden gutties with screw at an interval of not more than one meter as shown in fig.**
  - ☞ The V.I.R or P.V.C. cables are drawn by means of G.I. wire of size of about 18 SWG.
  - ☞ The earth wire is fixed by means of the earth clips. This system is generally employed in workshops or factories etc.
  - ☞ If metal conduits are used they are cut with hacksaw and are threaded with die-set for bends, junction boxes etc.
- ☞ **ii).Concealed conduit wiring:**
  - ☞ **In this system the conduit (nowadays P.V.C. is mostly used) is buried under the wall (plaster) or ceiling.**

## **Electrical Installation and Estimation (EE3105PE)**

---

- ☞ In this case first the channels are provided in the wall and then the conduits are fixed in the channels by means of clamps and hooks.
- ☞ Then the wires are drawn into the conduits by means of G.I wire.
- ☞ As the wiring is done under the plastic, so the whole of the system is made water tight to prevent the entering of moisture.
- ☞ It is generally used in domestic, offices, commercial etc.
- ☞ Now-a-days P.V.C. conduits are extensively used in place of steel conduits.
- ☞ They are cheaper in cost and require less time for installation.
- ☞ They provide good protection against acid, alkalies, oil and moisture.
- ☞ In P.V.C. conduits jointing is done with a special made solution.
- ☞ The main drawback of P.V.C. conduit is that it cannot withstand high temperatures, hence does not provide protection against fire.

### **Advantages:-**

- ☞ Metal conduit wiring provides protection against mechanical damage, moisture and fire etc.
- ☞ The life is sufficiently long.
- ☞ The system is water proof, chemical proof.
- ☞ Replacement of conductors, fault location and extension is easy.
- ☞ The wiring can be done in any place.
- ☞ Concealed conduit wiring gives good appearance.
- ☞ If metal pipe is earthed properly, this wiring is shock proof.

### **Disadvantages:-**

- ☞ This system is costly compared to any other wiring system.
- ☞ If the burs are not removed properly, they may damage the cable insulation.
- ☞ The installation of conduit wiring requires skilled labour, which increases the cost.
- ☞ P.V.C. conduit can not provide protection against fire.

### **Applications:-**



## Electrical Installation and Estimation (EE3105PE)

---

- ☞ It is most commonly used system in all places such as textile mills, saw mill, flour mills, work shops, factories etc. as it provides good protection against mechanical damage.
- ☞ It can be used in damp places, places where fire hazards are more and places where appearance is quite importance.

### 6.6 General Rules Related to wiring

- ☞ The wiring installation shall generally be carries out in conformity with the requirements of the Indian Electricity Rules.
- ☞ The following are some of the extracts of B.I.S (Bureau of Indian Standards) regulations pertaining to wiring installations and are recommended by the National Electrical Code (NEC).
- ☞ All fittings, accessories and appliances used in wiring installations shall conform to Indian standards (I.S. mark).
- ☞ Height of the main switch and distribution boards should be at a height of 3meters and all switch boards should be at a height of 1.5meters from floor level.
- ☞ All the lighting fittings shall be at a height of not less than 2.25m from the floor level.
- ☞ A switch and socket-outlets shall be installed at any height 1.3m above the floor level s desired.
- ☞ All plugs and socket-outlets shall be of 3-pin type, the earth pin of the socket should connect permanently to earth.
- ☞ No socket-outlet shall be provided in the bathroom at a height less than 1.3m.
- ☞ Unless otherwise specified, all ceiling fans shall be hung not less than 2.75m above the floor.
- ☞ If the voltage exceeds 250V, all the distribution boards and main switches should be provided with danger board.
- ☞ Total load in the circuit should not exceed more than 800 watt and number of points should not be more than 10.
- ☞ Power devices should have different circuits.

11) For lighting load the fuse wire should not exceed 5A capacity and for power load it is 10 Amp.

## **Electrical Installation and Estimation (EE3105PE)**

---

- 12) The size of a conductor should be such that the voltage drop should not increase more than 3% of the connected voltage when full load current is flowing.
- 13) The minimum size of the conductor in any sub-circuit should not be less than 1/1.12mm (1.0mm<sup>2</sup>) in case of Copper wire and 1/1.4mm (1.5mm<sup>2</sup>) in case of Aluminium wires.
- 14) All the accessories should be fixed on the round blocks or board with brass screws.
- 15) All the Iron clad appliance, switches etc. should be earthed.
- 16) Neutral should be linked.
- 17) All the switches should be connected though live wire, but not in neutral.
- 18) All the boards and switches should be fixed on left and side of the entrance.
- 19) Each apparatus should be controlled from a separate switch.
- 20) In wiring the live line of the supply should be Red, Yellow or Blue colour, and the colour of neutral and earth wire should be Black and Green respectively.

### **7. Electrical Wiring Accessories**

- ☞ **An electrical accessory Is a basic part used In wiring either for protection and adjustment or for the control of the electrical circuits or for a combination of these functions.**
- ☞ **The Electrical accessories used in wiring installations are classified according to their functions and use as below.**
  - ☞ **1. Controlling accessories (Switches).**
  - ☞ **2. Holding accessories (Lamp holders).**
  - ☞ **3. Outlet accessories (Plugs & sockets, ceiling roses etc.).**
  - ☞ **4. General accessories.**
  - ☞ **5. Safety accessories.**

#### **7.1 CONTROLLING ACCESSORIES**

- ☞ The accessories which are used to control the various appliances in electrical wiring (circuit) are known as 'controlling accessories'.
- ☞ All switches are control devices for various applications.
- ☞ **Switch :**
- ☞ A Switch is used t o break the electrical circuit.

## Electrical Installation and Estimation (EE3105PE)

---

- ☞ It should so, operate that it must make the circuit firmly and break the circuit without forming an arc between the switch blades and contact terminals.
- ☞ The arc formed may damage or burns the switch contacts.
- ☞ The switch is always connected in series with equipment (light, fan etc) to be controlled.
- ☞ A switch essentially consists of two parts namely Base and Cover.
- ☞ Base consists of switch blades and contacts.
- ☞ The cover provides protection to the contacts against mechanical damage.
- ☞ The switch is fixed to the wooden round block by means of screws.

### 7.1.1 Types of Switches

- ☞ **The switches can be classified in different ways as below.**

- ☞ **1. According to their function and place of use**

- ☞ (a) Surface switches or Tumbler switches.
- ☞ (b) Flush switches.
- ☞ (c) Pull or Ceiling switches.
- ☞ (d) Grid switches
- ☞ (e) Architrave switches.
- ☞ (f) Rotary switches.
- ☞ (g) Push button switches.
- ☞ (h) Bed switches.
- ☞ (i) Table lamp switches.
- ☞ (j) Iron-clad water tight switches.

- ☞ **2. According to operation required**

- ☞ One-way switches.
- ☞ Two-way switches.
- ☞ Two-way centre off switches.
- ☞ Intermediate switches.

- ☞ **3. According to number of poles**

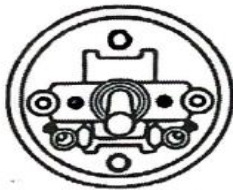
- œ Single-pole switches.
- œ Double-pole switches.
- œ Triple-pole switches.
- œ 4. According to type of Base material
  - œ (a) Porcelain switches.
  - œ (b) Bakelite switches.
- œ 5. According to shape of the Base
  - œ (a) Round switches.
  - œ (b) Square switches.
  - œ (c) Oblong (Rectangular) switches.
- œ 6. According to the colour of the Base
  - œ (a) White Base switches.
  - œ (b) Black Base switches.
  - œ (c) Brown Base switches.
- œ **7. Main Switches (Iron-clad switches)**
  - œ Double pole Iron clad switches (DPIC).
  - œ Triple pole Iron clad switches (TPIC).
  - œ Triple pole Iron clad with neutral link (TPICN).
  - œ Miniature Circuit Breaker (MCB).
- œ **8. Knife switches**
  - œ Single Pole Single Throw Switches (SPST).
  - œ Single Pole Double Throw Switches (SPDT).
  - œ Double Pole Single Throw Switches (DPST).
  - œ Double Pole Double Throw Switches (DPDT).
  - œ Triple Pole Single Throw Switches (TPST).
  - œ Triple Pole Double Throw Switches (TPDT).

### **1. According to their function and place of use**

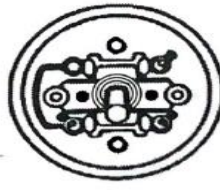
## Electrical Installation and Estimation (EE3105PE)

### ☞ (a) Surface or Tumbler Switches :

- ☞ These switches are fixed on the mounting block directly fixed on the surface of wall.
- ☞ Such switches projected out of the surface of the wall.
- ☞ The switches may be one-way or two-way and are available with round and oblong base.
- ☞ These are rated as 5A, 250 V (lighting switches) and 15A, 250V (power switches) etc.
- ☞ The different types of surface switches are shown in Fig.



(a) One-Way Switch (5 A)  
Cover removed



(b) Two-way switch (5 A)  
cover removed



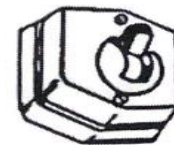
(c) 5 A or 15 A single pole, 1-way  
and two-way switch



(d) 5 A, Round base  
switch



(e) 5A, All black (Reno) 1-way  
or 2-way round type



(f) 5A, (Pilot) 1-way or 2-way  
Hexa Base



(g) 5A Oblong Switch



(h) 15 A, 3-Pin Switch  
Socket Combined



(i) D - P Switch



(j) 5 A, (Reno) Rexa  
1-way

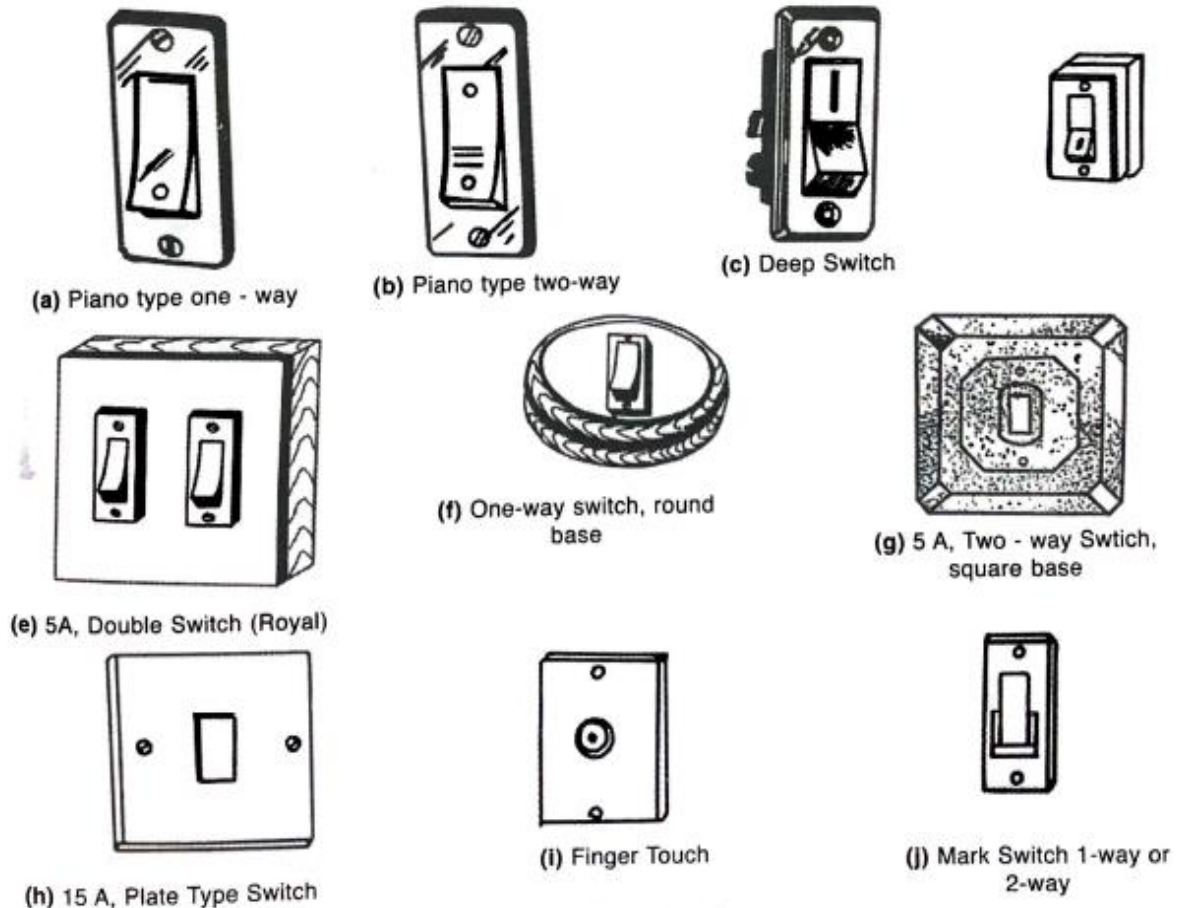
### (b) Flush Switches :

- ☞ As the name indicates, these switches are fixed in flush with the wall and they do not project out from the wall.
- ☞ These are used, where high quality performance and appearance are desired.
- ☞ In these switches, all current carrying parts are mounted on high grade vitreous porcelain base enclosed in an iron/ wood box recessed into the wall.
- ☞ These are some times known as piano type switches.

## Electrical Installation and Estimation (EE3105PE)

☞ They are made for 5 A, 250 V and 15 A, 250 V etc. Now-a-days, these are extensively used for newly constructed houses.

☞ The various types of flush type switches are shown in Fig.



### (c) Pull or Ceiling Switches :

☞ These switches are fixed on the ceiling (roof) and all the live parts are away from the operator.

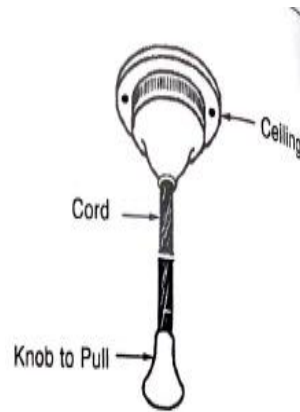
☞ It functioning as a one-way switch to make or break a circuit.

☞ These are operated with a single pull on the cord for the ON and OFF position.

☞ These are used in bath rooms for operating water heaters, in bed rooms for operating lights or fans and for decoration lights etc.

☞ The Pull switch with its position is shown in Fig.





**(d) Grid Switches**

- ☞ These are similar to that of surface switches, but they are light in weight and small in size.
- ☞ They are used with portable machines such as drill machines, portable grinder etc.
- ☞ They are made either in one-way or two-way pattern both for 5 A and 15 A rating.
- ☞ These are also called Toggle switches and are shown in Fig.



Grid Switch for Grinders etc.



Grid Switch for House Wiring

**(a) Grid Switches**

**(e) Architrave Switches**

- ☞ In this type the switch movement is enclosed in a compact porcelain base as shown in Fig.
- ☞ A cover plate shown in Fig. is fixed to this Architrave switch by means of screws.

- ⌘ These switches cannot operate without cover plate and they are available in one-way and two-way pattern.



Architrave Switch

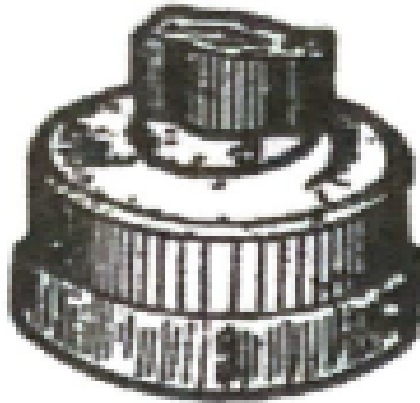


Cover Plate

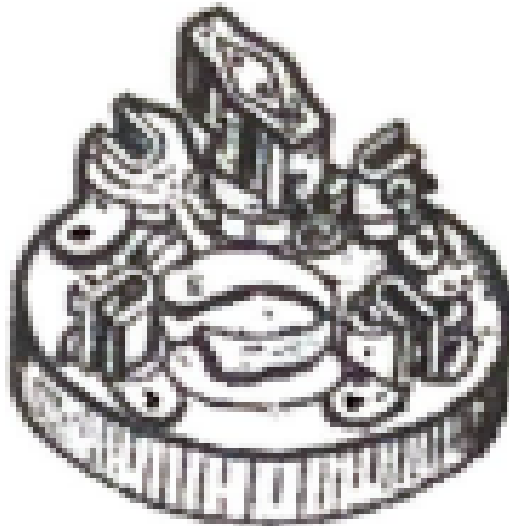
**(b) Architrave Switch**

### **Rotary Switches**

- ⌘ These switches consist of an insulated handle (knob) to which the blades are fixed.
- ⌘ So whenever the handle is rotated, the blades move in steps and make in contact with the terminals to which the wires connected.
- ⌘ The best example of Rotary switch is a fan regulator, when it is in one position fan rotates at a particular speed and if regulator rotates to other position fan rotates at different speed.
- ⌘ The typical rotating switches are shown in Fig



(a)



(b)

**(g) Push Button Switches**

- ☞ These switches are mainly used for controlling the electric bells.
- ☞ It consists of only one blade. When the knob (button) is pressed, the movement of the blade is controlled by a cam and spring, thus they open or close the circuit.
- ☞ These switches are also used for starting motors and controlling the light in refrigerator which lights when the door is opened and goes off when the door is closed.
- ☞ Typical push button switches is shown in Fig.



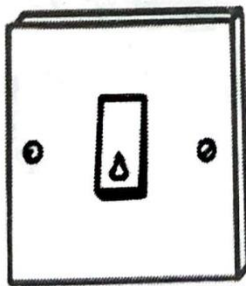
(a) Interior View



(b) Surface Type



(c) Push Type



(d) 5A, Push Type



(e) Metal Flush Type



(f) Unbreakable Flush Type

### PROCEDURE OF FIRST - AID IN CASE OF ELECTRIC SHOCK

- ☞ We do not know when we will come across an electrical accident to some body, may be at home or office or industry.
- ☞ It is always better and necessary to know how to give first aid to such victims before arranging to send the victim to the doctor.
- ☞ Removal of Victim from Supply :
- ☞ The victim if found fallen on the ground or in sitting position in an unconscious state always suspect that the victim is still in contact with the electric supply.
- ☞ In an anxious state never touch the victim .
- ☞ The event of such a mistake you will also fall into the trap.
- ☞ Ascertain whether the victim is still in contact.
- ☞ If so, you should stand on a dry wooden plank and remove the victim, otherwise, pull the victim using a dry rope or coconut matting or stick.
- ☞ If possible stand on a rubber mat.

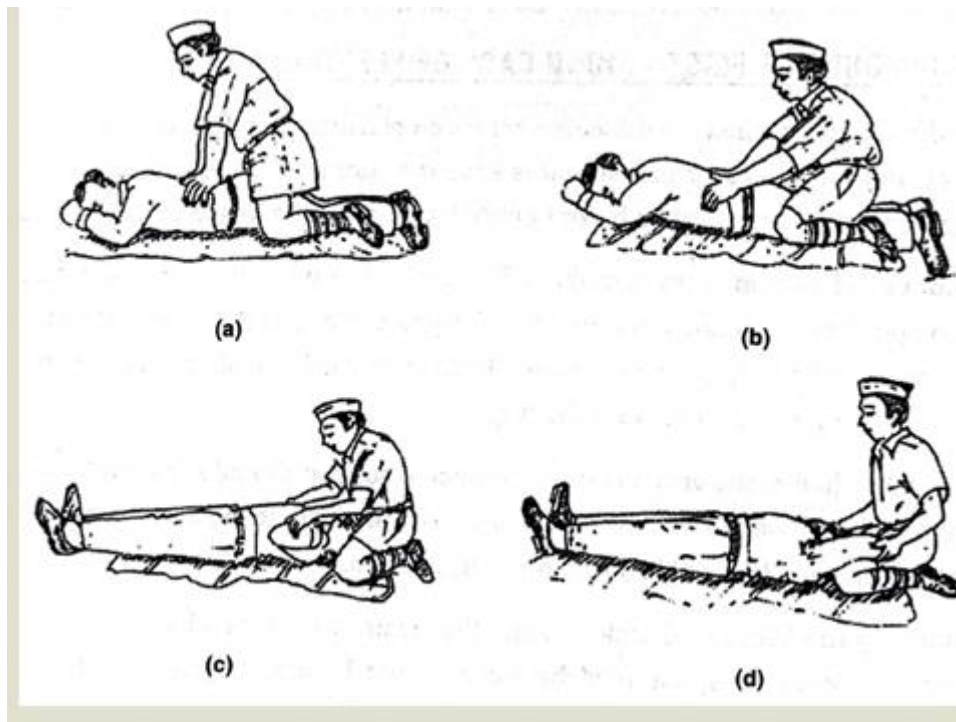
## Electrical Installation and Estimation (EE3105PE)

---

- ☞ Checking the Victim : Check whether the victim is still breathing send a message to bring the doctor.
- ☞ If apparently the victim is not breathing, give FIRST AID till the doctor arrives to give further treatment.

### METHOD – I

- ☞ Keep the victim as shown in Fig. (a) with the face downwards.
- ☞ Kneel over the victim 's back placing both the hands on the patient's back near the lowest rib such that the fingers are spread ·outwards while the thumbs of both the hands almost touch each other and are parallel to the spine.
- ☞ Rock yourself gently forward, keeping your arms straight pressing slowly for about seconds as shown in Fig (a).
- ☞ Now slowly release the pressure and come to the kneeling position.
- ☞ Repeat this process at the rate of about 15 times a minute.
- ☞ The purpose is to expand and contract the victims lungs and cause breathing.
- ☞ Continue this operation till the natural breathing is re-established. it 'may take a long time i.e. , 31 minutes or even one hour to get the expected result.
- ☞ If the victim starts breathing, it is better to synch(once your actions until the victim breaths strongly.
- ☞ In some cases it so happens that the victim after a temporary recover of respiration, again stops breathing. It is therefore, very' much necessary to check the, breathing of the victim continuously, and-if natural breathing stops, artificial respirator should be given as explained above.
- ☞ Caution : It is important that an unconscious victim should never be given a m drink.



### ☞ **METHOD – II**

- ☞ Alternatively, if it is advantageous to place the victim on his back, do so, and loosen his cloths around the chest and stomach. Place a pillow under his shoulders.
- ☞ The aim is to make his head fall backwards.
- ☞ Draw his tongue forward and proceed as follows .
- ☞ You should kneel in a position as shown in Fig. (c).
- ☞ Hold the victim just below his elbows and draw his arms over his head until they are horizontal to the ground.
- ☞ Keep them there for about 2 seconds. Bring the patients arms down on each side of his chest, pressing inwards up so as to compress his chest.
- ☞ Keep the arms in this position atleast for 2 seconds.
- ☞ Repeat the above two positions at the same rate. It is always better if we draw out the patients tongue during each lung inflating (inhalted position) stroke (Fig. (c) and release it during each lung deflating stroke (exhaled position as in Fig. (d).

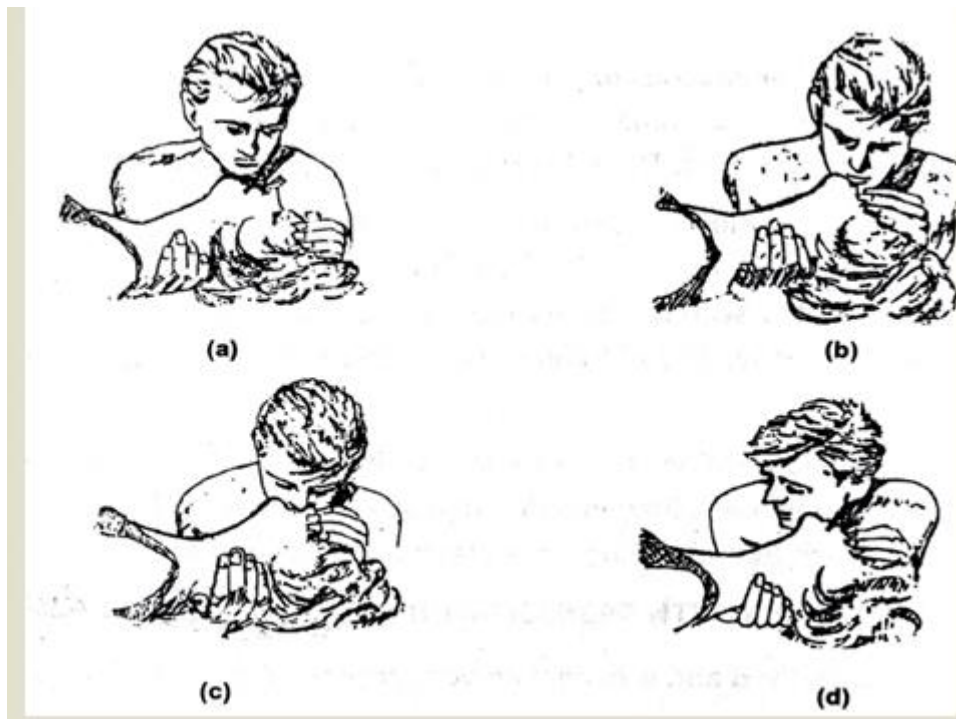
### ☞ **METHOD• III : (MOUTH TO MOUTH RESUSCITATION)**

- ☞ This is very good method and is becoming very popular.
- ☞ The procedure is as follows :



## Electrical Installation and Estimation (EE3105PE)

- ☞ Place the patient, so as to lie on his back. If. there is some foreign matter like tobacco, chocolate etc., in the mouth, remove it, this will make the air passage clear.
- ☞ Step 1 : Open the airway of the patient by lifting his neck with one hand while your other hand tilts his head back and down as far\_ as possible such that the chin points upwards (Fig. (a)).
- ☞ Step 2 : Pinch the nostrils (nose) to prevent air leakage. Maintain the open airway by keeping the neck elevated (Fig. (b)).
- ☞ Step 3 : Seal your mouth tightly around the victims mouth and blow the air in . The patients chest should rise (Fig.(c)) .
- ☞ Step 4 : Remove your mouth. Release the patients nostrils. Listen for air escaping from the patients lungs . Watch for the patients chest to fall.
- ☞ Steps 2 , 3 and 4 make one · breathing in - breathing out cycle.
- ☞ Repeat this cycle by following steps 2, 3, and 4 at 12 to 15 times a minute.
- ☞ Continue until medical help arrives or breathing in the victim is restored.
- ☞ For young ones (infants) cover the entire mouth and nose with your mouth.
- ☞ Use small puffs of air about 20 times per minute.



## UNIT – II

### Estimation of Lighting and Power Loads

#### Introduction

- Estimation means to determine the quantity of various materials required to execute a job and to assess the cost of the execution.
- Before taking the work in hand for execution, it becomes necessary to chalk out a list of quantity of various materials, its cost and labour involved for the completion of the work satisfactorily.
- Thus estimation consists of two parts :
  - 1. Preparing list of various materials involved and
  - 2. Calculating the cost of materials and labour cost involved for executing the work.
- The quantity and specification of various materials required for installation work written in a tabular form is called schedule of materials.
- Before estimating the quantity of materials and their cost, it is need to prepare building plan on a suitable scale and mark electrical points, switch boards, main board, meter board, distribution board etc. on the plan using specified symbols.
- The path of wiring showing connection to each point is marked by a little thick line.
- An important principle in the selection of symbol is that, as far as possible, they should be self explanatory and easy to draw.
- Sometimes, the conditions which are not specified in the question may be assumed conveniently.
- Ex : Location of main switch board, switch boards, height of building etc.

#### 1.WIRING SYSTEMS

- A network of wires/ cables connecting various electrical accessories for distribution of electrical energy from the supplier meter board to the number of electrical energy consuming devices such as lamps. Fans, T.V, refrigerator and other domestic appliances through controlling (switches) and safety (fuses, MCB etc.) devices is known as “Wiring System”. ,
- The supply used in houses for lighting and power purposes is single phase supply(for industries three-phase A.C. supply is employed).
- The single phase circuit is connected across 220/230 volts, across one phase and neutral.

### **2. TYPES OF SERVICE MAIN (SERVICE LINE)**

The line or cable that brings electric energy from the supplier's distributing lines to the consumer's premises is known as service line or service connection or service main.

Service lines are of two types namely :

- (i) Overhead service line.
- (ii) Underground cable service line.

#### **Overhead Service Line :**

The service line provided above the ground level is known as overhead service line.

When the service line is provided with the help of an overhead line, it must be fixed minimum clearance above the ground and a definite clearance must be provided from the adjacent buildings.

- For overhead service line All Aluminium Conductor (AAC) or ACSR or Hard drawn copper of different sizes are used according to the load of the consumer.
- These are again sub divided into :
- (a) Weather proof service line and (b) Bare conductor service line.

#### **Underground Cable Service Line :**

- The service line provided below the ground level is known as Underground service line.
- This type of connection is used where it is not possible to provide overhead service line and where it is necessary to improve the beauty of the building.
- Low tension 31/2 core cable is used for underground service line.
- It is preferred when the power to be supplied to the consumer is above 25KW.

### **3. SELECTION OF SERVICE MAIN**

The selection of type of service line depends upon the conditions and given situations.

Different service lines and the various methods used for installation are discussed below.

For Overhead Service Line : The various methods for installation of overhead service lines are given below.

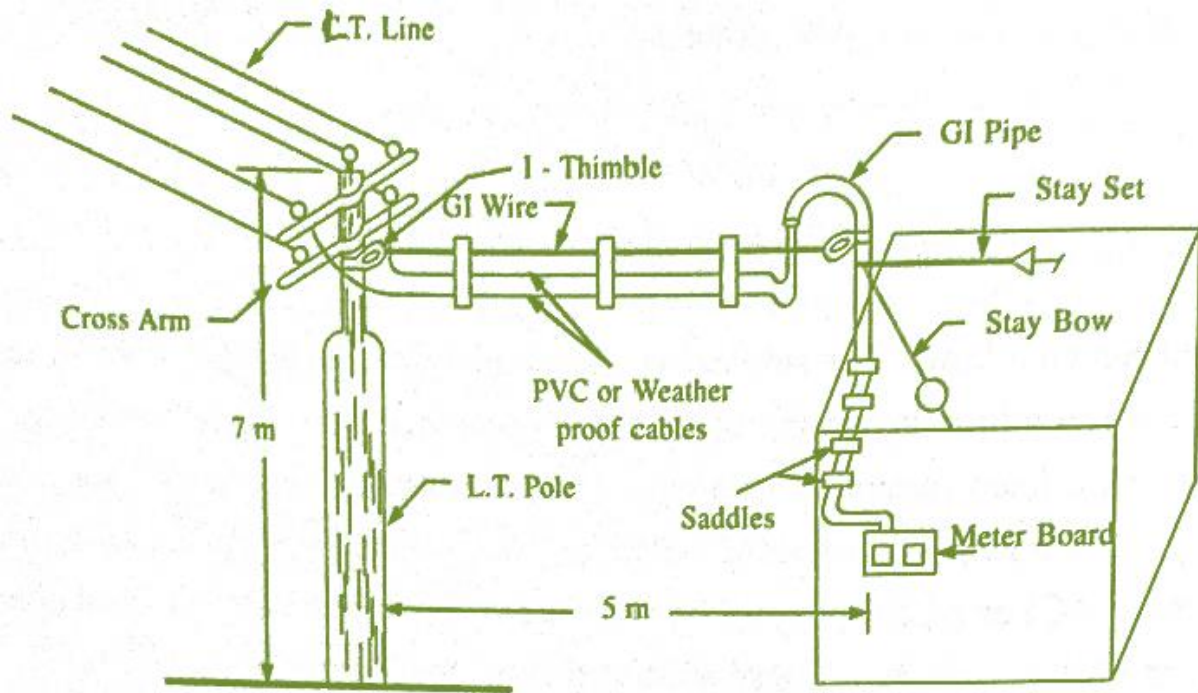
#### **(a) Weather Proof Cable Method :**

This method is most commonly used for domestic, commercial, offices etc where the distance between distribution line or L.T pole and consumer premises is less than 40 meter.

## Electrical Installation and Estimation (EE3105PE)

A G.I. wire of 8 SWG is stretched between service pole and G.I pipe which is raised above the roof.

The weatherproof (or PVC) cable is then brought to the building by clipping it to the G.I wire as shown in Fig. 2.1 (a) Whether proof cable can withstand against atmospheric conditions like temperature, rain, dust etc.

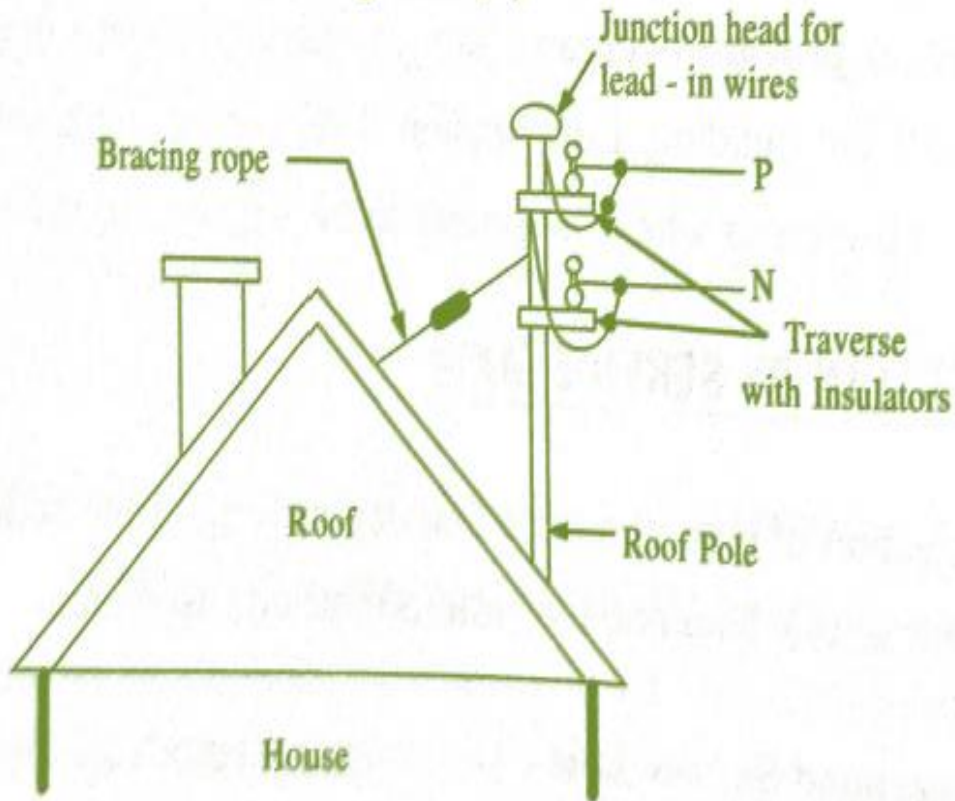


(a) Weather Proof Cable Service Connection

Fig 2.1 :

(b) Roof Pole Connection for Low Roof Buildings

- If the height of the building is very low, service bracket cannot be fixed to the walls of the building.
- In such situations a roof pole is provided with cross arms for fixing insulators to which conductors are fixed as shown in Fig. 2.1 (b).

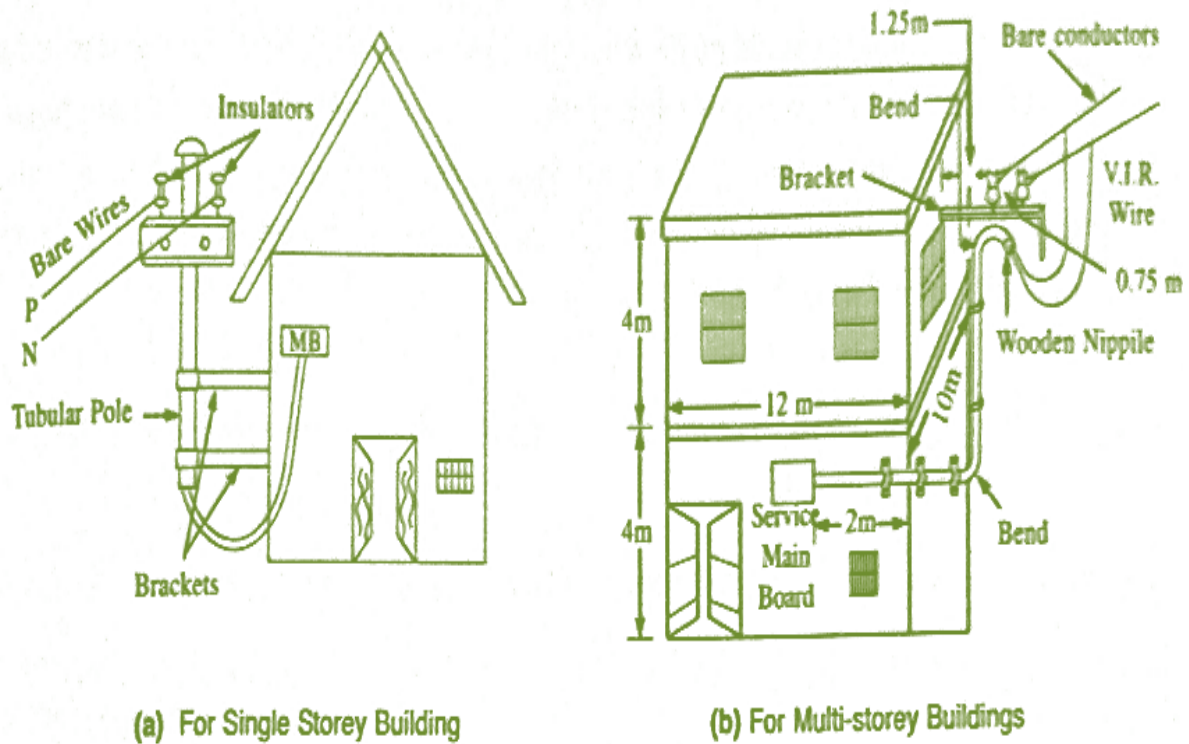


(b) Roof Pole Connection

Fig 2.1 :

**(c) Bracket Pole Connection with Bare Conductor Service Line**

- This method is used where it is not possible to use weather proof cables i.e. Where the distance of distribution lines or nearest L.T pole is more than 40 m.
- In this method a bracket is embedded into a wall at a suitable height with pin or shackle type insulators.
- The bare conductors are brought from nearest LT pole and connected to the insulators.
- Now weather proof cable (or PVC cable) are connected to the bare conductor and carried through G.I pipe upto the meter board as shown in Fig. 2.2.

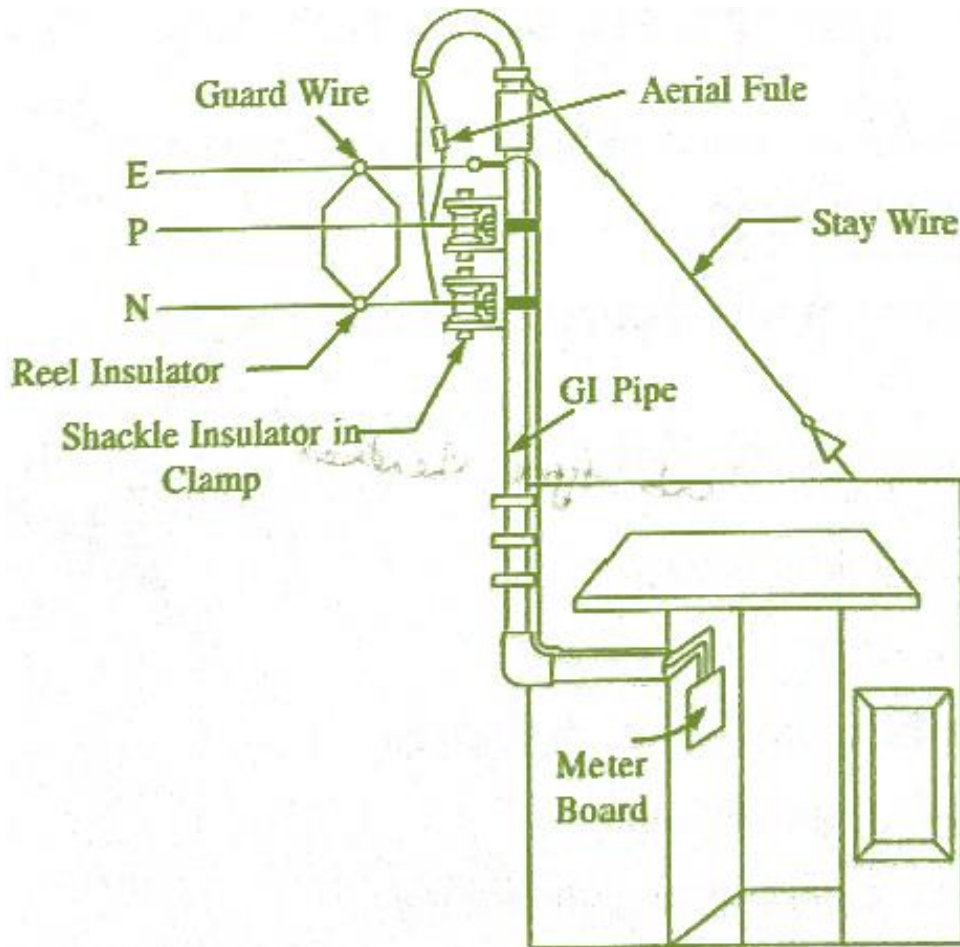


**Fig 2.2 : Bare Conductor Service Line**

(d) G.I Pipe Service Connection

- In this method G.I pipe is fixed to the wall and raised above the roof to a suitable height.
- The G.I pipe is properly supported by means of stay wire. The shackle insulators are fixed to the G.I pipe and bare conductors are brought from nearest L.T pole and connected to shackle insulators.
- The weather proof cable (or PVC cable) are connected to the bare conductor and carries through the same G.I pipe upto the meter board as shown in Fig. 23.

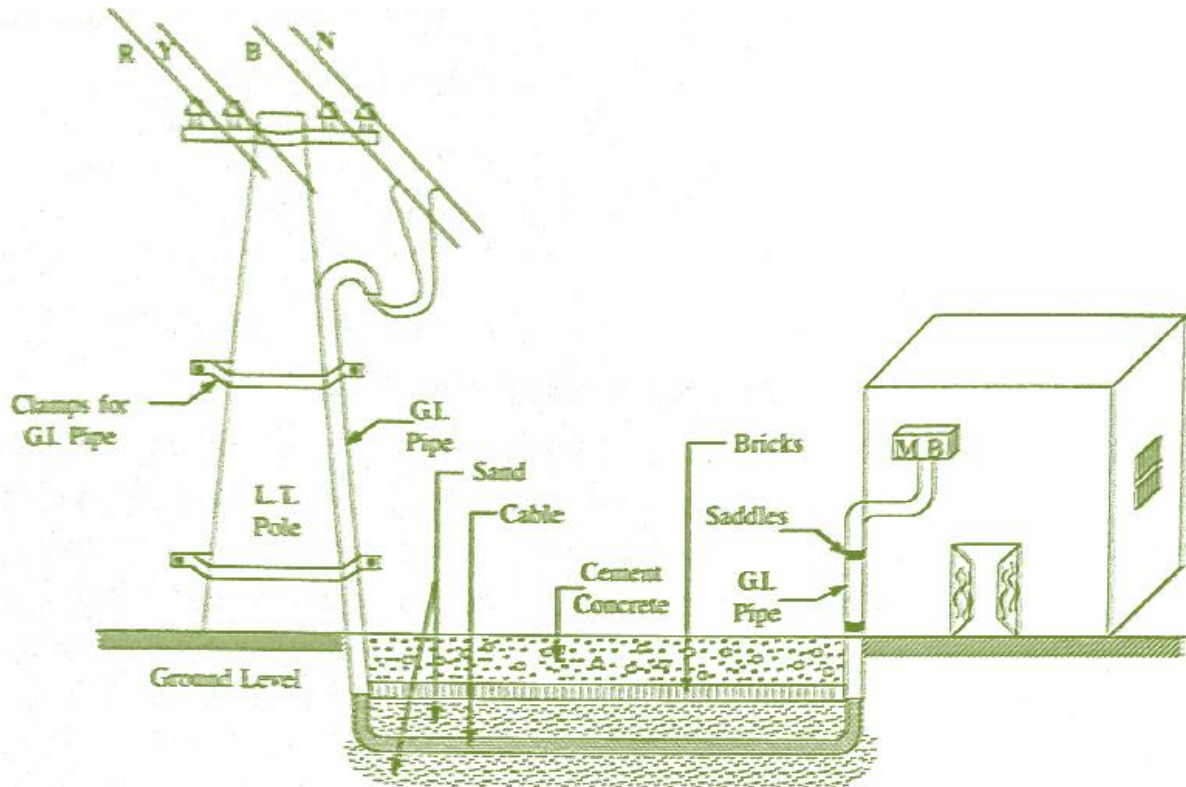




**Fig 2.3 : G.I Pipe Service Connection**

## 2. Underground Cable Service Connection

- Underground cable service connection is used when it is not possible to use overhead service line and where there is some restriction to pass overhead service lines.
- In this installation a trench of about 1 meter deep and 0.5 meter wide is made along the road or as required.
- The cable is laid in the trench and cover with sand and bricks.
- Now both ends of the cable are passed through the G.I pipes.
- one end is connected to distribution line and another end of the cable to the energy meter.
- The pipes are properly secured to the L.T pole and wall as shown in Fig 2.4.



**Fig 2.4 : Underground Cable Service Connection**

- There are several systems of wiring in common use. They are
  1. Cleat wiring.
  - 2 CTS. (TRS. wiring)
  3. Wooden casing-capping wiring
  - 4 Lead-sheathed wiring.
  5. Conduit wiring, which are further divided as
    - (a) Surface conduit wiring and
    - (b) Concealed or recessed conduit wiring.
- Each system has its own merits and demerits.

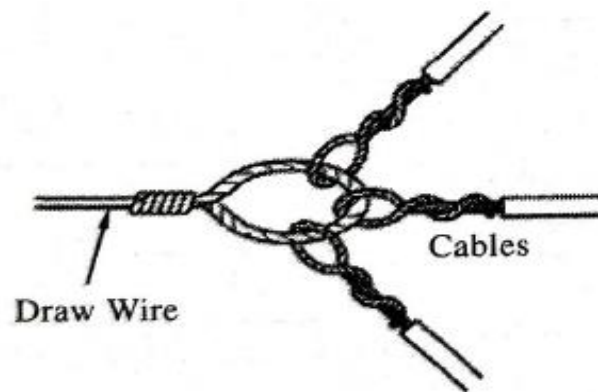
#### **4. SELECTION OF SYSTEM OF WIRING**

- Though there are several systems of wirings, no one system is suitable for all installations.
- Great care must be taken in the selection of a particular system of wiring for a particular job.
- The various points to be considered before selecting a particular type of wiring are :
  - (i) Durability : The wiring system should withstand wear and tear due to weather.
  - (ii) Safety : The wiring system should be no danger of leakage or shock to a person while using.
  - (iii) Mechanical Protection : The wiring must be protected from mechanical damages during its use.
  - (iv) Appearance : It should give good appearance from architectural point of view.
  - (v) Permanency : The wiring must not be affected by the action of weather, fumes, dampness etc.

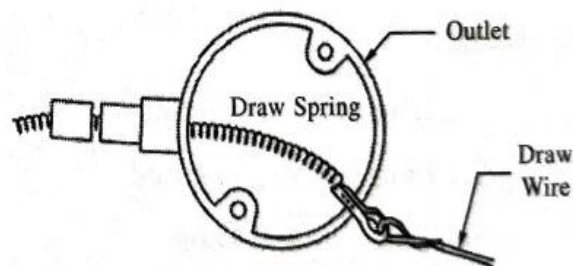
- (vi) Accessibility : It should be accessible for future extension.
- (vii) Cost : The cost of the system should be economical.

### 5.DRAWING A WIRE/CABLE THROUGH A CONDUIT

- Cables should not be drawn into a conduit system until the conduit system is completed.
- Usually, a spring or G.I wire is used to draw the cable into conduits. The spring or G.I wire should not be used for drawing directly cables as it may get damaged.
- Hence, the cable ends must be bared for a distance of about 75 mm and threaded through a loop in the draw wire.
- The draw-wire is secured to the spring, and feed the spring into the conduit as shown in Fig. 2.5.



(a)



(b)

### 1. ELECTRICAL SYMBOLS

- In engineering symbols are used in layouts and wiring circuits to represent the electrical parts and various accessories.
- Since, the drawing of the actual device at every time is very laborious and difficult to a person.
- In selecting symbols, they should be as far as possible self crests and easy to draw.
- Symbol represents only the function of apart/accessory irrespective of the structure.
- Some of the symbols which are standardized by Bureau of Indian Standards are given below.

**(a) Current :**

- |                              |       |   |
|------------------------------|-------|---|
| 1. Direct current (D.C.)     | ..... | + |
| 2. Alternating current (A.C) | ..... | ~ |
| 3. Power frequency           | ..... | ~ |
| 4. Either A.C or D.C         | ..... | ± |

**(b) Distribution System :**

- |                                          |       |                  |
|------------------------------------------|-------|------------------|
| 1. A.C. single phase, 50 Hz              | ..... | 1 - 50 Hz        |
| 2. A.C. three phase, 50 Hz               | ..... | 3 - 50 Hz        |
| 3. A.C. three phase, 50 Hz, 415 V        | ..... | 3 - 50 Hz, 415 V |
| 4. A.C. three phase, with neutral, 50 Hz | ..... | 3N - 50 Hz.      |
| 5. D.C. two wire conductor               | ..... | 2 - 110 V        |
| 6. Positive                              | ..... | +                |
| 7. Negative                              | ..... | -                |
| 8. Phase                                 | ..... | Ph               |
| 9. Neutral                               | ..... | N                |

## Electrical Installation and Estimation (EE3105PE)

**(c) Lines :**

- |                                 |           |           |
|---------------------------------|-----------|-----------|
| 1. Line or cable existing ..... | —————     | —————     |
| 2. Line or cable planned .....  | - - - - - | - - - - - |
| 3. Underground cable .....      | —————     | ≡≡≡       |
| 4. Over head Line .....         | ○         | ○         |

**(d) Conductors :**

- |                                                    |       |       |
|----------------------------------------------------|-------|-------|
| 1. Conductors or group of several conductors ..... | ————— | ————— |
| 2. Flexible conductors .....                       | ~~~~~ | ~~~~~ |
| 3. Two conductors .....                            | //    | //    |
| 4. Three conductors .....                          | ///   | ///   |
| 5. n - conductors .....                            | /     | /     |

**(e) Terminals and Connection of Conductors :**

- |                                                 |        |  |
|-------------------------------------------------|--------|--|
| 1. Terminal .....                               | ○ or ● |  |
| 2. Junction of conductors .....                 | ├      |  |
| 3. Double junction of conductors .....          | ├ or ┤ |  |
| 4. Crossing without electrical connection ..... | ┆      |  |
| 5. Crossing with electrical connection .....    | +      |  |
| 6. Earth .....                                  | ⏏      |  |
| 7. Fault .....                                  | ⚡      |  |

**6. LIST OF ELECTRICAL MATERIALS & THEIR APPROXIMATE RATES (SCHEDULE FOR RATES)**

- The various materials used in house wiring and service main are given in the Table. 2.1 along with their approximate latest rates.
- The rates of materials are inclusive of all taxes such as sales tax, excise duty, transportation charges etc.
- The rates may not be constant but depends on quality, company and other so many factors.



## Electrical Installation and Estimation (EE3105PE)

Table 2.1 :

S.No.	Material with Specification	Rates		Remarks
		Rs.	Ps.	
<b>(A) Electrical Materials/ Accessories :</b>				
1.	I.C.D.P. switch, 15A, 250 V grade with fuse unit	350/each		
2.	1-way Iron Clad Distribution Board 15 A/way, 250 V with fuse unit	200/each		
	2-way Iron Clad Distribution Board 15 A/way, 250 V with fuse unit	250/each		
	3-way Iron Clad Distribution Board 15 A/way, 250 V with fuse unit	300/each		
	4-way Iron Clad Distribution Board 15 A/way, 250 V with fuse unit	325/each		
	5-way Iron Clad Distribution Board 15 A/way, 250 V with fuse unit	350/each		
3.	Miniature Circuit Breaker, 5 A, 250 V	250/each		
	Miniature Circuit Breaker, 15 A, 250 V	275/each		
4.	Double Pole (D.P) flush type switch with neon indicator, 15 A, 250 V	250/each		
5.	I.C. Cut-outs, 15 A, 250 V	100/each		
6.	<b>Switches</b>			
	(i) Surface (Tumbler) switches, 5 A			
	(a) One-way	15/each		
	(b) Two-way	25/each		
	(ii) Flush type switches, 5 A			
	(a) One-way	20/each		
	(b) Two-way	25/each		
	(iii) Surface switch, 15 A	30/each		
	(iv) Flush type surface, 15 A	35/each		
	(v) Bed switch, 5 A	15/each		
	(vi) Bell switch (push button), 5 A	20/each		



## Electrical Installation and Estimation (EE3105PE)

7.	<b>Lamp holders</b>		
	(i) Batten type (Brass)	25/each	
	(ii) Batten type (Bakelite)	20/each	
	(iii) Pendant type (Brass)	20/each	
	(iv) Pendant type (Bakelite)	18/each	
	(v) Bracket type (Brass)	45/each	
	(vi) Bracket type (Bakelite)	40/each	
	(vii) Water tight bracket with holder and shade	60/each	
8.	(i) Socket, 2-pin, 5 A, 250 V surface type	20/each	
	(ii) Socket, 3-pin, 5 A, 250 V surface type	25/each	
	(iii) Socket, 3-pin, 15 A, 250 V surface type	40/each	
	(iv) Socket, 2-pin, 5 A, 250 V flush type	25/each	
	(v) Socket, 3-pin, 5 A, 250 V flush type	30/each	
	(vi) Socket, 3-pin, 15 A, 250 V flush type with neon and switch control	45/each	
9.	(i) Ceiling rose, 2-plate, 5 A (Jimbo)	20/each	
	(ii) Ceiling rose, 3-plate, 5 A	30/each	
	<b>(B) PVC Insulated Cables :</b>		
1.	1/1.4 mm (1/18) or 1.5 Sq.mm single core, 650 V grade aluminium conductor PVC cable.	10/metre	
2.	1/1.8 mm (1/14) or 2.5 sq.mm single core, 650 V grade aluminium conductor PVC cable	15/m	
2.5	1/1.12 mm (1.0 mm <sup>2</sup> ) single core, 650 V grade copper conductor PVC cable	15/m	
3.	1/1.4 mm (1/18) or 1.5 Sq.mm single core, 650 V grade copper conductor PVC cable	20/m	
4.	1/1.8 mm (1/14) or 2.5 Sq.mm single core, 650 V grade copper conductor PVC cable	25/m	
5.	1.5 Sq.mm 650 V grade multi-strand flexible PVC cable	16/m	
6.	2.5 Sq.mm 650 V grade multi-strand flexible PVC cable	20/m	
7.	3-core, 3.8 Sq. mm or 3/20, 650 V grade copper PVC cable	15/m	
8.	7-core, 13.85 Sq. mm or 7/16, 650 V grade Aluminium conductor weather proof cable	25/m	for service line

### 6.1 GENERAL I.E RULES WHILE PREPARING THE INTERNAL WIRING

**ESTIMATION** The general rules, which are to be kept in mind in execution of internal wiring are,

## **Electrical Installation and Estimation (EE3105PE)**

---

1. The meter board, main switch and distribution board are to be kept at a height of 2 m from floor level.
2. The switch board should be kept at a height of 1.5m from floor level.
3. The height at which conduit run on the wall (Horizontal run) may be 3.0 m from ground level.
4. The conductor used is to be of such a size it should carry load current safely. The minimum size of conductor cable used is 1/1.12 mm (1.0 mm<sup>2</sup>) for copper and 1/1.40 mm (1.5 mm<sup>2</sup>) for Aluminium conductor.
5. Every sub-circuit is to be connected to a distribution fuse board. The load on each sub-circuit is to be restricted to 800 watts. Each sub-circuit is not to have more than a total of 10 points of lights, fans and lighting socket outlets (2 or 3-pin, 5 A). The load on each power sub-circuit should not exceed 3000 watts (3-pin, 15 A plug sockets) and should not have more than 2 socket outlets. All the socket outlets should be controlled by individual switches. The earth pin of the socket should be connected permanently to the earthing system. It is better to provide a socket at a height of 1.5 m from floor level. Some times it is needed to provide a socket below 1.5 m, then it is better to provide inter locked socket-outlet to avoid danger to children, The light or fan wiring and power wiring are to be kept separately.
6. Suitable number of socket-outlets are to be provided at suitable place in all rooms and one or two 3-pin, 15 A socket outlets are to be provided in kitchen.
7. All batten holders from incandescent lamps are provided at a height of 3.0 m from floor level. The clearance between bottom of a ceiling fan and pendant holder and floor should be 2.75 m.
8. All the sub-circuits should have its own continuous earth wire.
9. The distance between ceiling and horizontal run may be taken as 0.25 to 0.5 meters, but it depends on the type of the building.
10. Any wiring system has to service at least for 20-25 years, hence high quality materials are to be used. High workmanship must be executed through qualified contractor/engineer. Hence material cost and labour charges may be high.

### **6.2 STEPS TO ESTIMATE INTERNAL WIRING**

- Before proceeding to prepare an estimate for internal wiring scheme, it is necessary for the electrical engineer to go through the plan, total points & their location.
- It is a challenging job to estimate different materials coming in wiring scheme and it is very difficult to estimate very accurately, but from the site plans a sufficient accurate estimate can be made.
- The following steps will help in estimate of wiring scheme.

## Electrical Installation and Estimation (EE3105PE)

---

- Step-1 :
- Determination of Number of Sub-circuits :The number of sub-circuits is decided as per the number of points to be wired and total load to be connected to the supply system. The number of points to be wired may be known from the plan and the total load can be known from the wattage of each point. For determining the total load the following wattage may be assumed if not specified.
  - 1. Incandescent (Filament) lamp - 60 watt
  - 2. Fluorescent tube lamp - 40 wait
  - 3. Fan point - 80 wait
  - 4 Socket-outlet (lighting), 5 A - 100 watt
  - 5. Power socket-outlet, 15 A - 1000 watt
- Step-2 :
- Determination of Size of the Conductor, Main Switch and Distribution Board :The size of the conductor cable depends on the current carrying capacity. The current can be calculated by dividing total load with voltage (current = power/voltage). But the minimum size of the cable is 1/1.12 mm (1.0 Sq.mm) in copper or 1/1.4 mm(1.5 Sq.mm) in aluminium. The size of the main switch depends on the current to be controlled by it. The size and type of distribution board depends on current rating and number of sub-circuits to be connected to it.
- Step-3 :
- Determination of Size and Length of the Conduit/Batten :The size of conduit/batten depends on number of wires passing through it. The length of the conduit/batten can be determined by going through the plan of the building i.e. through horizontal run, vertical up and vertical down. The vertical up is the length of conduit from horizontal run to ceiling and vertical down is the length from horizontal run to switch boards.
- Step-4 :
- Determination of Length of Conductor Cable :The determination of length of the cable/wire is very laborious process. As a general rule length of the cable is approximately 3 times that of the length of the conduit/batten, out of which the phase wire is approximately double the length of that of the neutral wire.
- Step 5
- Determination of Earth Wire :All metal parts, metal coverings of all appliances should be properly earthed to avoid danger from electrical shock due to leakage or failure of insulation. Hence, earth wire is required for socket outlets and main switches. Generally G.I wire of 14 SWG is sufficient as earth wire. The earth wire can be

## Electrical Installation and Estimation (EE3105PE)

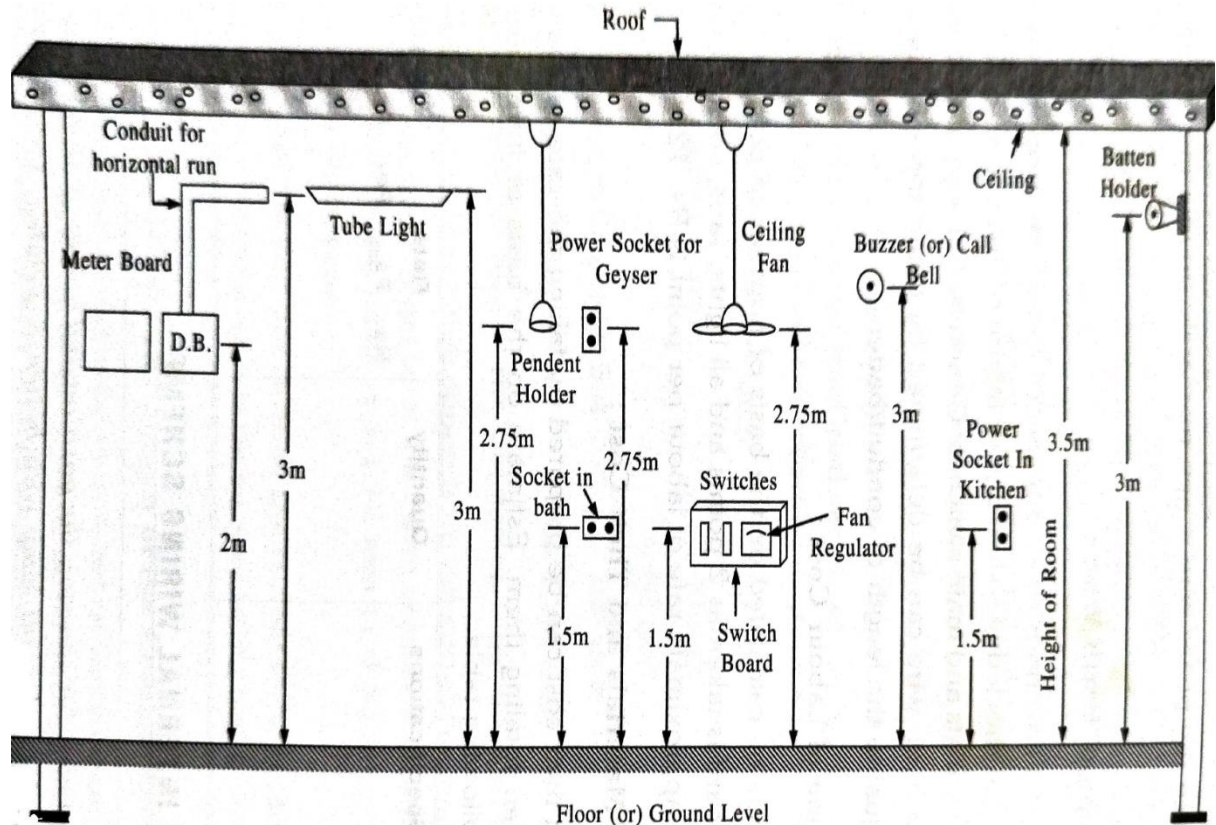
determined by going through the conduit (earth wire is approx. equal to the length of conduit/batten).

- Step 6
- Determination of Labour Cost :The labour cost may be calculated on the basis of number of points. The main board and distribution board is taken as 2 points and all lights, fans, socket outlets are taken as one point. The approximate rate of labour per point is Rs. 125/-.
- Step 7
- Estimate of Materials and Their Cost :The materials and their cost can be prepared by taking the rate of each item/material separately and then totaling them. Estimate on the basis of item wise rates can be prepared in the following table.

### PROBLEMS ON INTERNAL WIRING SCHEME

#### Problem -1

- Draw a neat section view for showing the position and height of Meter board, Main switch, Distribution board, Incandescent lamp with batten & pendent holders, Fluorescent light on wall, Ceiling fan, Call bell or Buzzer, Switch board and Socket outlets (both light & power sockets).

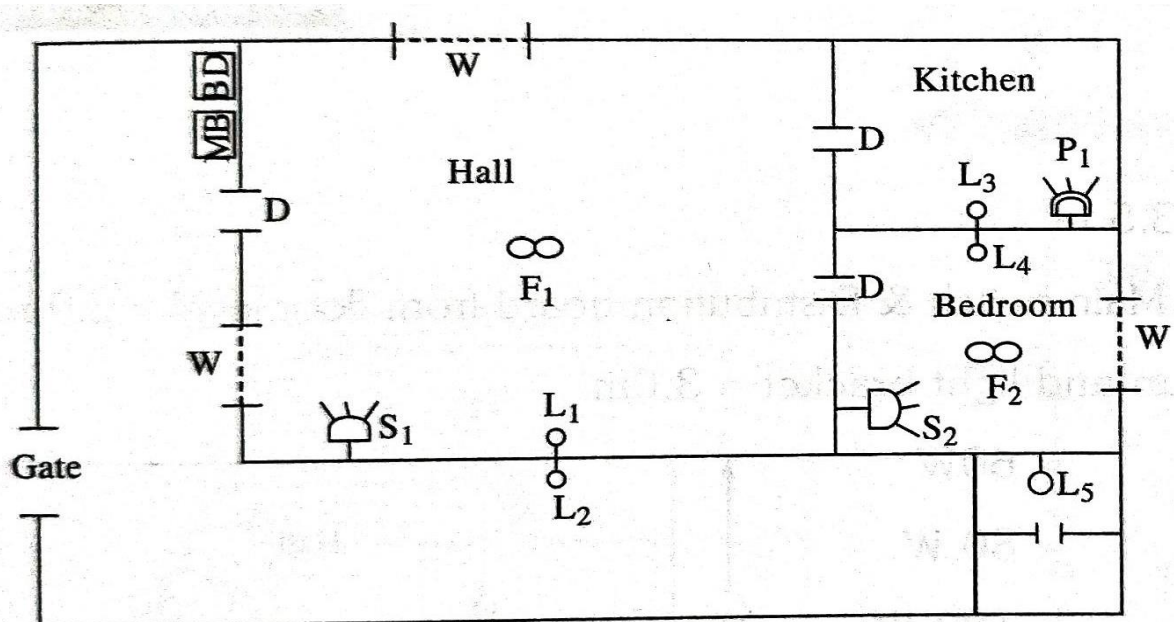


#### Problem-2



## Electrical Installation and Estimation (EE3105PE)

- Estimate the number of sub-circuits and size of the Main switch, Distribution board and the cable required for a residential building which is provided with various electrical installations as shown in the plan.
- Hint : M.B = Meter Board, D.B = Distribution Board, D=Door, W=Window, S1 & S2= Light Sockets '1 & 2' (SA), P1=Power Socket '1'.



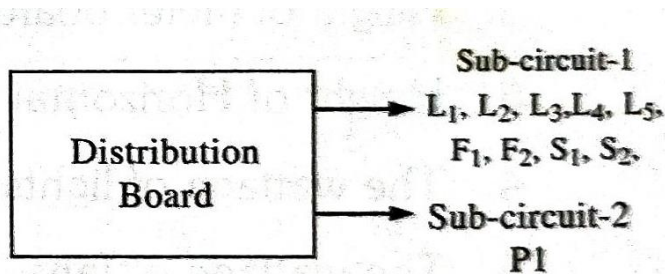
(a) Plan

**Fig 2.7 : Plan**

- No. of light points = 5
- No. of fan points = 2
- No. of light sockets = 2
- **1. No. of Sub-Circuits :**
- As per the recommendations of ISI the wattage of each light may be taken as 60 W, fan as 80 W and light socket as 100 W for estimation purpose. Hence,
- Total wattage of lights =  $5 \times 60 = 300\text{W}$
- Total wattage of fan =  $2 \times 80 = 160\text{W}$
- Total wattage of light sockets =  $2 \times 100 = 200\text{W}$
- Total = 9 points = 660 W
- Wattage of power socket = 1000 W

## Electrical Installation and Estimation (EE3105PE)

- Since number of points to be connected are 9 points (less than 10) and load is 660 W (less than 800W), one sub-circuit is required for light load.
- Separate sub-circuit is required for power load (power socket). Because light and power load should be connected separately.



### (b) Sub-circuits

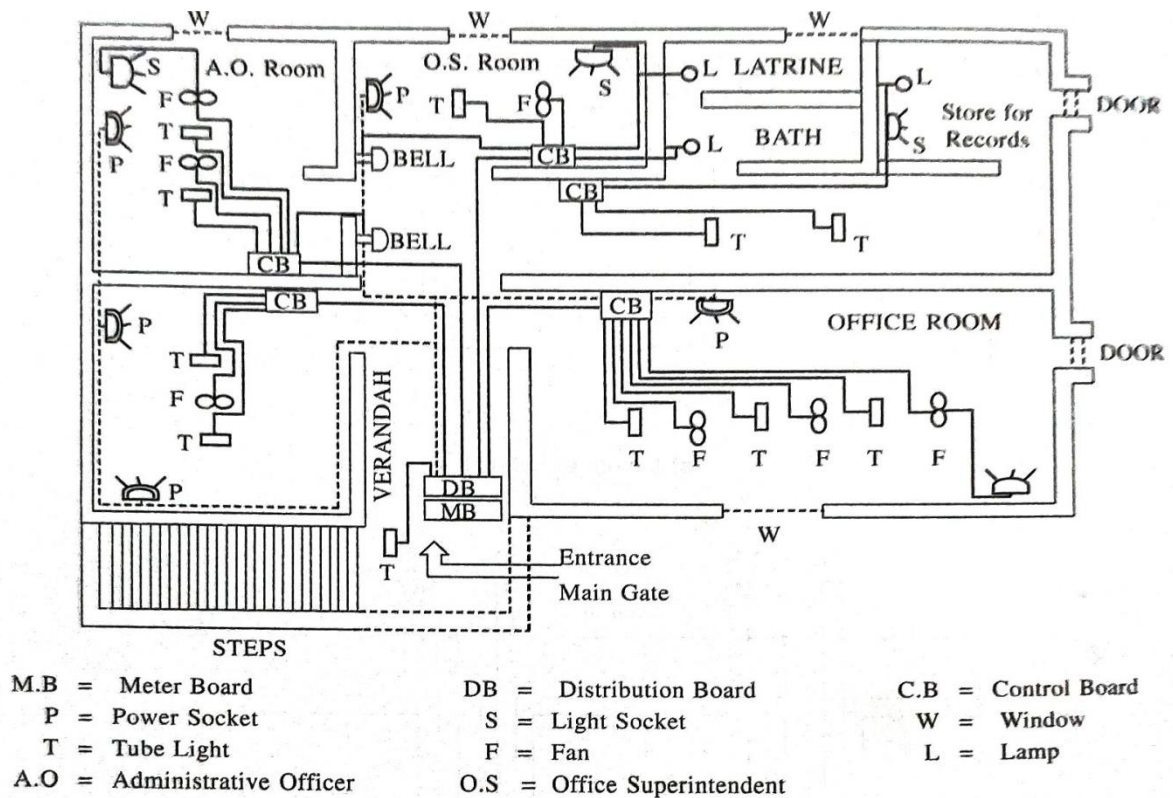
- Full load current of sub-circuit-1 =  $660/230 = 2.869$  A
- Full load current of sub-circuit-2 =  $1000/230 = 4.347$  A
- Hence, 15A, 250V I.C.T.P. Main switch is required to carry a current of 7.216 A ( $2.869 + 4.347$ ).
- A 2-way Iron Clad Distribution Board, 15 A/way, 250 V with fuse unit is required.
- From Table 1.1 and 1.2 for the above current the size of the cable required for both sub-circuits is 1/1.12 mm ( $1.0 \text{ mm}^2$ ) copper or 1/1.4 mm ( $1.5 \text{ mm}^2$ ) aluminum conductor single core 650V grade PVC cable for both phase and neutral wires.

## 8. WIRING LAYOUT OF A OFFICE BUILDING

- Wiring layout of an office is shown in Fig, Various rooms in office are indicated with sufficient lighting arrangement.
- The bell switches (push button) are provided in office room to call attender.
- Light and power socket outlets are provided in each room to provide connections to coolers, table fans etc.

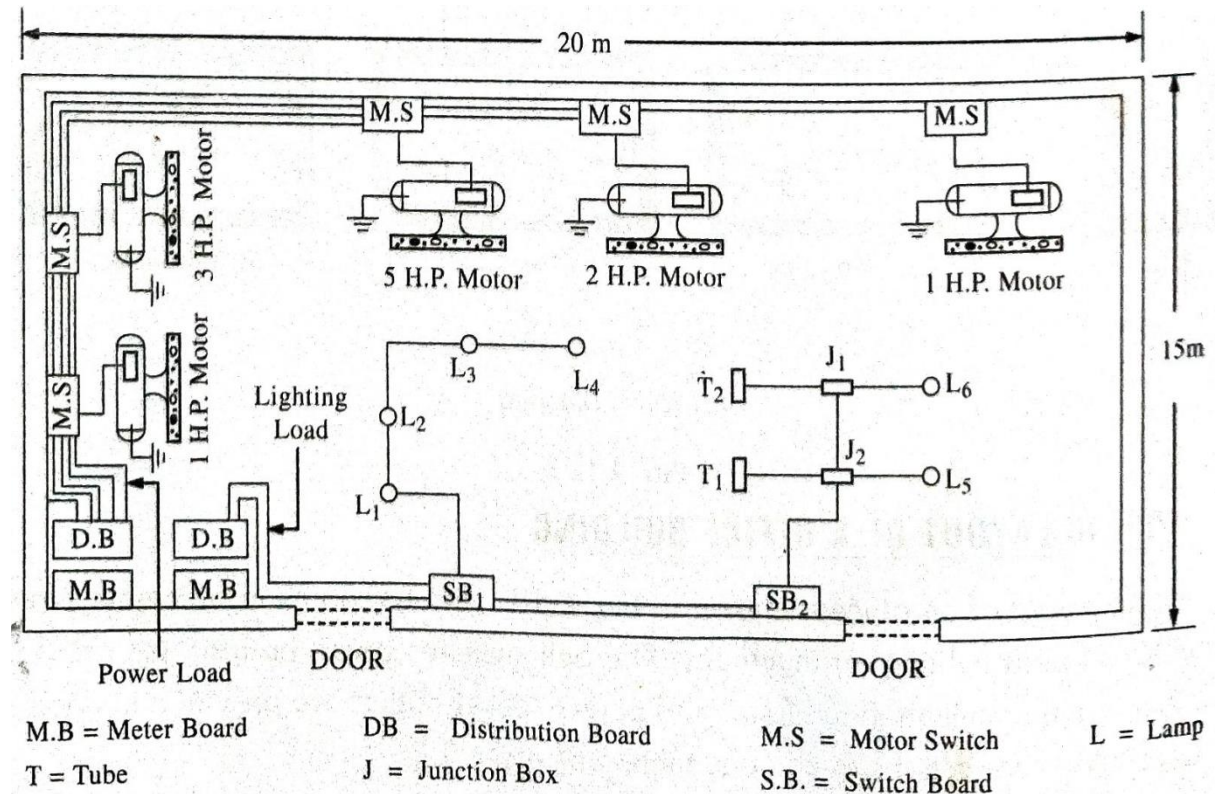


## Electrical Installation and Estimation (EE3105PE)



**Fig 2.18 : Wiring Layout of a Office**

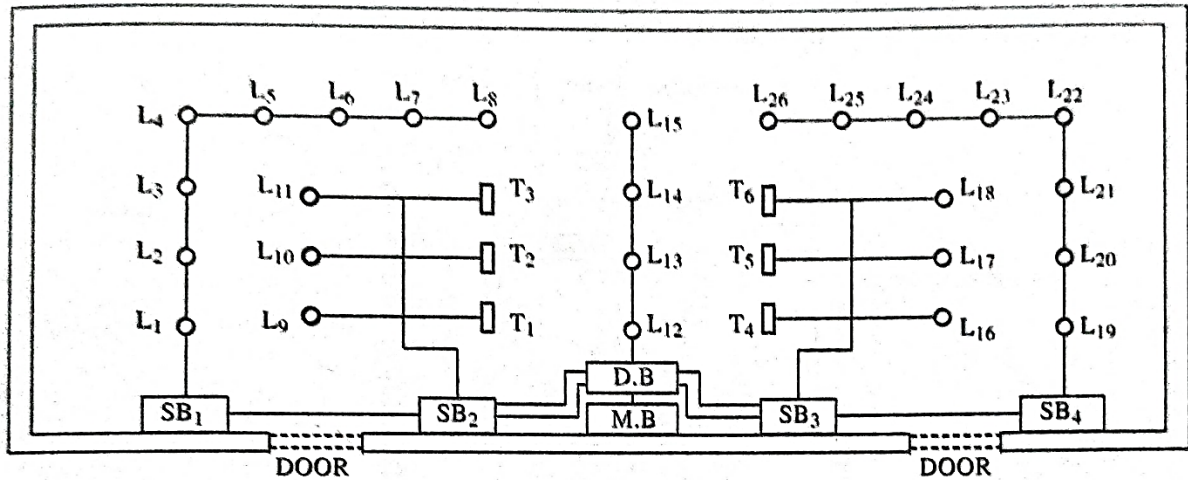
### 9. Wiring Layout of Work Shop/ Electrical Laboratory



**Fig 2.19 : Layout of Work Shop/ Electrical Laboratory**

## Electrical Installation and Estimation (EE3105PE)

### 10. WIRING LAYOUT OF A INDUSTRY | MILK DAIRY/CEMENT FACTORY/SUGAR FACTORY

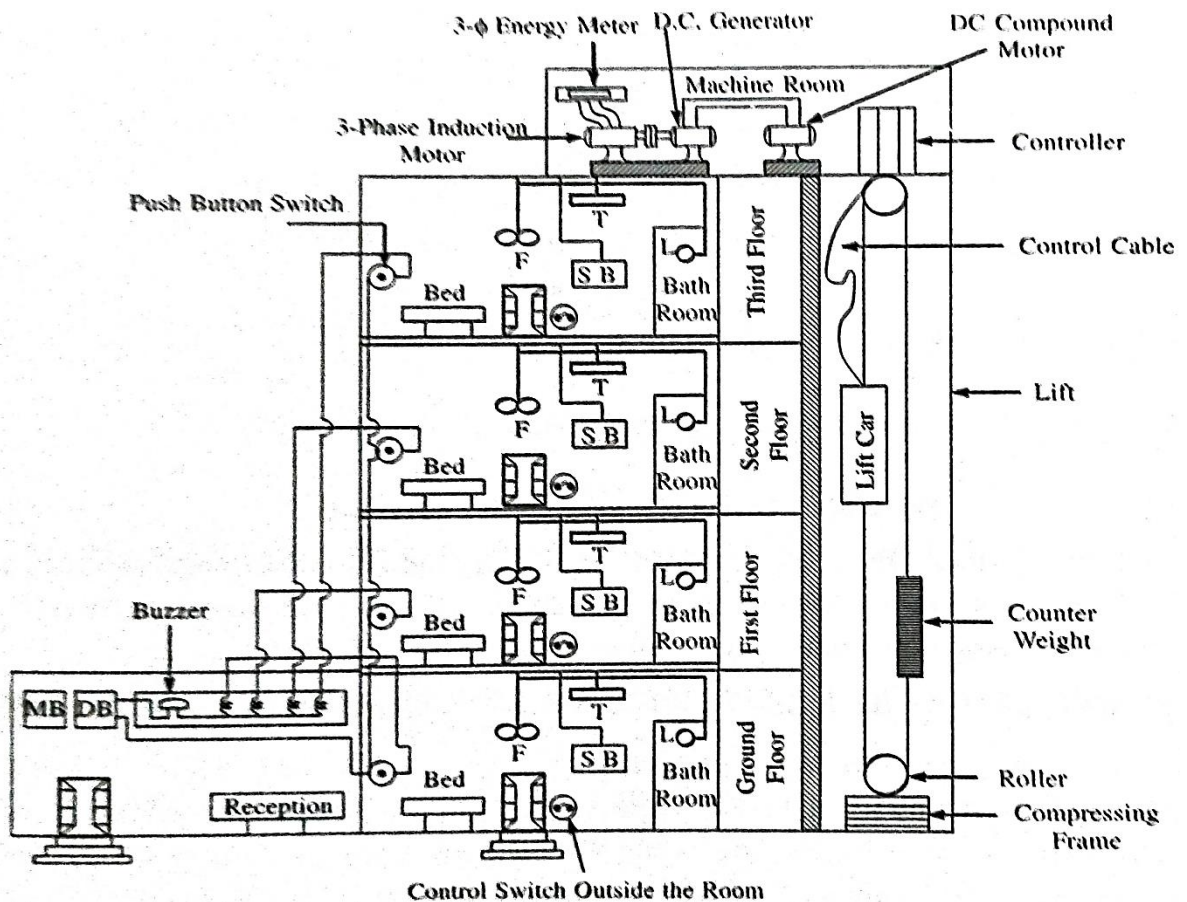


M.B = Meter Board  
L = Incandescent Lamp

DB = Distribution Board  
T = Tube

S.B = Switch Board

### 11. WIRING LAYOUT OF A HOTEL WITH A 4-STORIED WITH LIFT ARRANGEMENT



### 11. ESTIMATION OF POWER LOAD

## Electrical Installation and Estimation (EE3105PE)

We are well familiar with estimation of lighting circuits (domestic installation), now we will focus our attention on estimation of power circuits (loads) i.e., installation of motors upto 20 kW load.

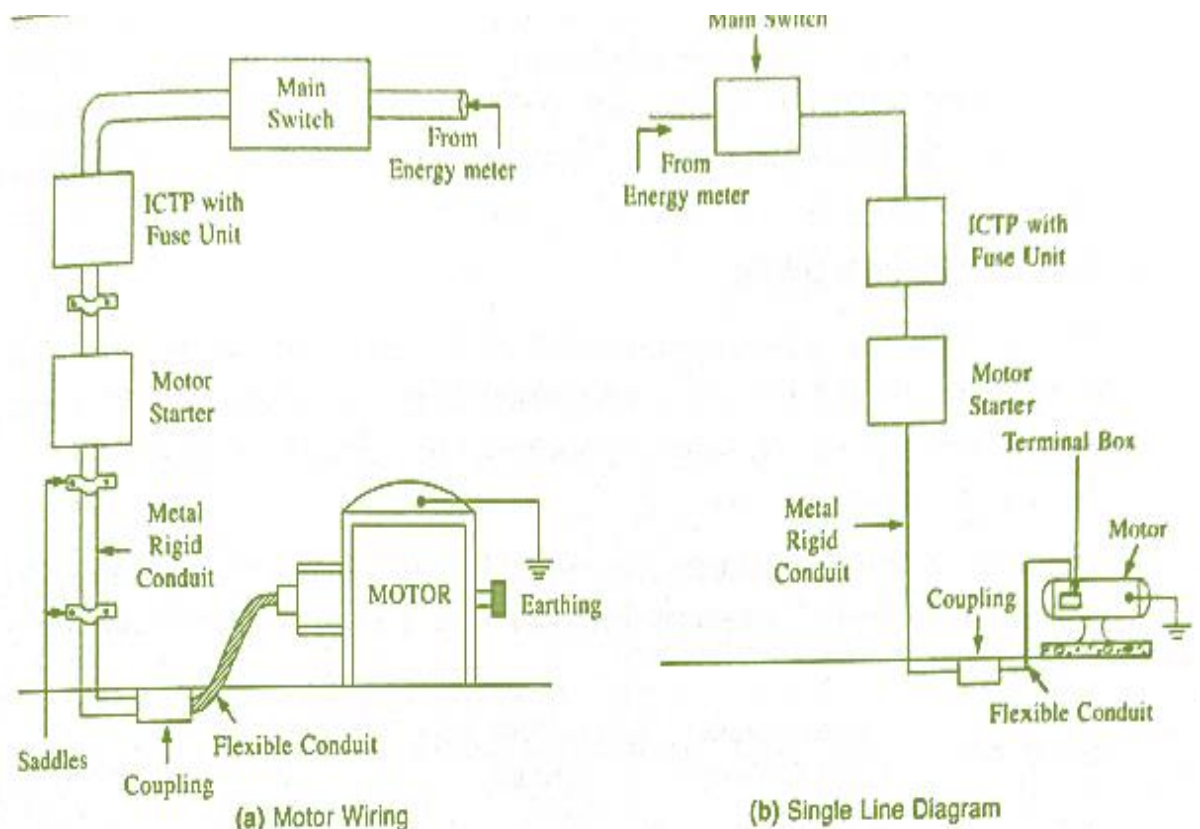
The power circuits can be divided into two groups, namely :

**1. Power circuit for heaters, refrigerators, air-conditions and other similar loads**

**2. Power circuits for motors, generators and other special purpose large load.**

### 13. SINGLE LINE DIAGRAM

- Fig. illustrates the electrical installation for motor.
- The motor has its own Iron Clad Triple Pole switch and Motor starter and are placed at a height of 1.5 m from ground level.
- The main purpose of starter is to limit the starting current to a desirable value. D.O.L, Star/Delta, Auto-transformer starter, Rotor rheostat starter starters are commonly used for starting the motors.
- From the meter board the supply is fed to the Main board (consists of main switch and distribution board). From distribution board the power is fed to the motor through motor switch and motor starter.
- The size of the I.C.T.P switch and starter depends on the rating of the motor. The frame of the motor shall be earthed by using 8 SWG G.I. wire (double earthing is more effective).



### 14. TYPE OF WIRING SYSTEM



## Electrical Installation and Estimation (EE3105PE)

- A rigid metallic (heavy gauge) surface conduit is used for power installations, because surface conduit facilitates the additions of number of motors in future and fault finding is easy.
- The rigid heavy gauge conduit is used from Distribution board to Motor base.
- A **flexible metallic conduit** is used to connect the end of the rigid conduit (at motor base) to the motor terminals.
- The rigid conduit and flexible conduit are coupled by means of box connector coupling. Flexible conduit is also used to connect motor switch to motor starter.
- The conduit used must be electrically continuous throughout and connected to the frame of the motor and is properly earthed.
- The conduit should perfectly be laid in covered trench to facilitate safety to the operator and **the trench is about 0.2 m deep**.
- The size of the conduit may be of size **19 mm dia to 51 mm dia depends on number of cables** running through it.
- For lights with in the industry/workshop should provided with separate cable and in separate sub-circuit.
- The lights used may be fluorescent tube lamp, sodium vapour lamp or mercury vapour lamp, because working area needs much illumination.

### 15. SIZE OF THE CABLE/WIRE

$$\begin{aligned}\text{Input in watts} &= \frac{\text{Output in watts}}{\text{Motor efficiency}} = \frac{\text{Rated BHP} \times 735.5}{\text{Efficiency}} = \frac{5 \times 735.5}{0.85} \\ &= 4326.47 \text{ watt}\end{aligned}$$

We know that, Input power =  $\sqrt{3} V_L I_L \cos \theta$ , Hence

$$\text{Input full load current } I_L = \frac{\text{Input power}}{\sqrt{3} V_L \cos \theta} = \frac{4326.47}{\sqrt{3} \times 415 \times 0.8} = 7.523 \text{ A}$$

$$\text{Starting current} = 2 \text{ times the full load current} = 2 \times 7.523 = 15 \text{ A}$$

Hence, from Table 1.2 and 1.3, 2.0 mm<sup>2</sup> single core copper conductor having a current carrying capacity of 15 A or 2.5 mm<sup>2</sup> single core aluminium conductor having current carrying capacity of 15 A may be required.

### SIZE OF CONDUIT, DISTRIBUTION BOARD, MAIN SWITCH AND STARTER

- The size of conduit always depends upon number of cables and size of the wire/cable to be carried.
- As a general rule, it is better to use 19 mm heavy gauge conduit where 3 wires are to be run and 25.4 mm heavy gauge conduit where 6 wires are to be run.
- Generally for each 3-phase motor 3 cables (2 cables for 1-phase motor) are required from Meter board to Motor starter and 6 cables/wires (2 cables for 1-phase motor) are required from starter to motor terminals.

## Electrical Installation and Estimation (EE3105PE)

---

- The following conduits are needed at different distances for 3-phase and 1-phase motors.

### STEPS TO SOLVE PROBLEMS ON POWER LOAD

The following steps help in solving problems on power load installation

Step 1: Determination of Size of The Cable : Calculate the full-load current and starting current of the motor. The size of the cable can be determined from the Table 2.2 and 2.3 for corresponding starting current.

Step-2 :

Determination of Size of The Conduit : Select 19 mm diameter Heavy gauge metal conduit where 2 or 3 wires are to be run and 25.4 mm Heavy gauge metal conduit where 6 wires are to be run.

Step-3 :

Determination of Length of The Conduit : Length of the conduit can be calculated by going through the layout of the plan.

Step-4 :

Length of The Cable : The length of the cable can be determined by multiplying the conduit by the number of wires passing through it for a particular length.

- Step-5 :
- Determination of Earth Wire : It can be determined by going through the conduit.
- Step-6 :
- Labour Cost : It is based on number of days and number of motors to be installed. The Labour charge can be calculated by multiplying the Electrician rate and helper rate with number of days.
- Step-7 :
- Estimation of Materials and Their Cost : The cost can be calculated by multiplying the quantity of the material with their rates in the table as below.

### 18.ESTIMATION OF IRRIGATION PUMP SETS

- Irrigation is an artificial application of water to plant roots with the purpose of assisting the growth of agricultural crops. Fertilizer and chemicals can be added to an irrigation system.
- Irrigation starts with sourcing water for the crop from groundwater or surface water from a channel or storage pond.
- The estimation of irrigation pump sets is same as that of power wiring estimation.

## Electrical Installation and Estimation (EE3105PE)

---

- The motor used in irrigation (Agricultural) purpose is Induction motor, which is coupled to a pump that pumps water from a well.
- The motor and pump set are installed in a room called pump-shed.
- All civil construction and foundation work of the pump-shed should be fully completed before the installation of the motor-pump set.
- The pump-shed must have enough space for the installation.
- The pump-shed should be clean, dry and warm, the motor never be installed in dusty and damp room.
- The switch board (panel board) is placed at a height of 1.5 m and the horizontal run may be 2.5 m for ground level.
- A 25.4mm dia heavy gauge metal conduit is provided on the —roof for the entry of service connection from the nearest L.T pole to connect to switchboard.
- A two-core (twin core) weather proof aluminium conductor, 1100 V grade cable is used as service connection.
- The conduit used from switch board to motor base may be 25.4 mm dia heavy gauge rigid metal conduit and is run on the surface.
- The conduit used from motor base to motor terminals is 25.4 mm dia flexible metal conduit.

### 19.MATERIALS USED IN IRRIGATION PUMP SET INSTALLATION

- The materials used in estimation of irrigation pump set are similar to that of power wiring installation.
- But the switch board is provided with three indicating lamps(OW/25W, 250 V) between each phase and neutral to know whether the power exists in each phase or not.
- One Voltmeter (0-500 V) between any two phases and one Ammeter (0-50 A) in series with any phase are provided in switch board to know voltage and current.
- In addition to these materials a single phasing preventer is provided in switch board to detect the single phasing condition.

### SINGLE PHASING CONDITION

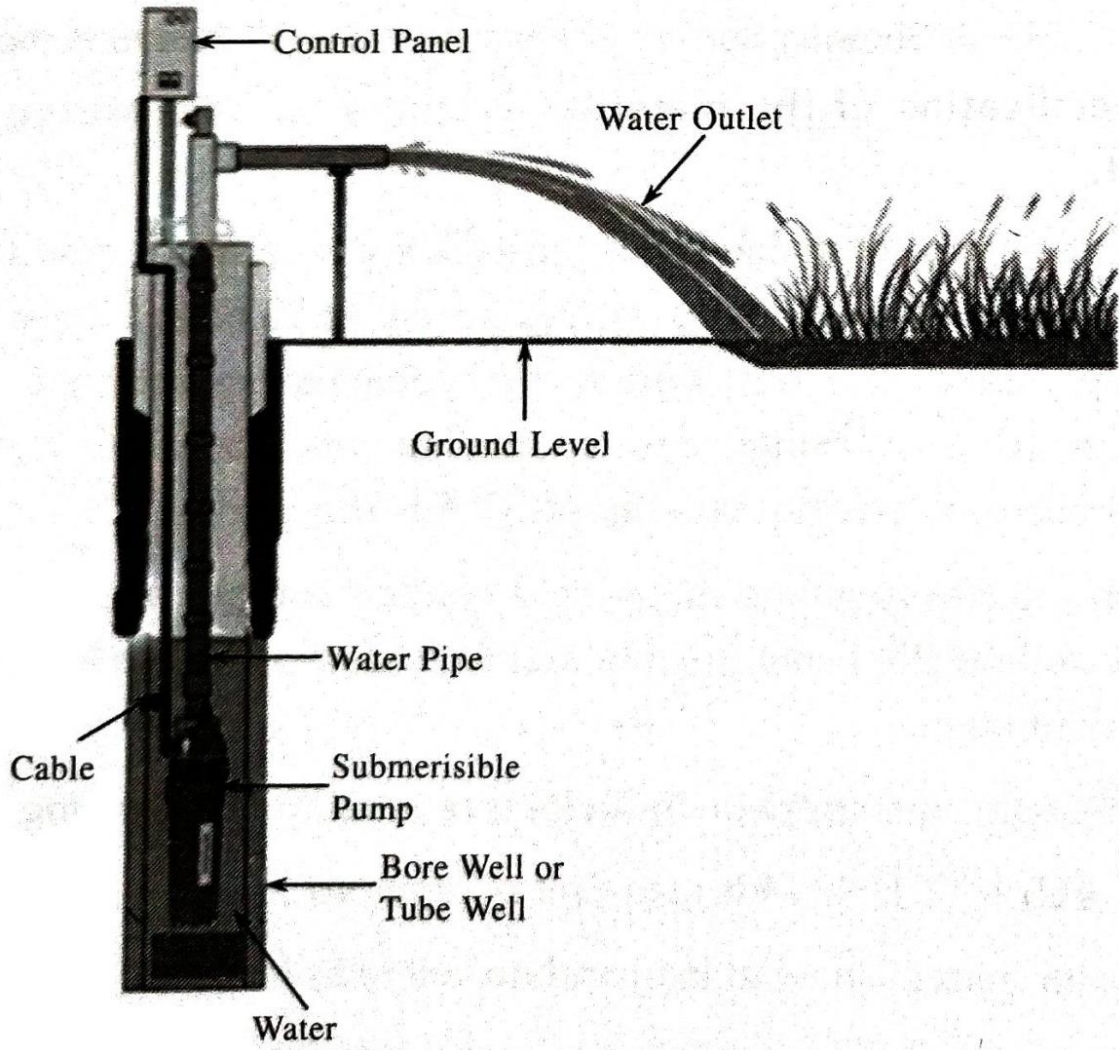
- The accidental opening of one of the supply lines (due to blowing of fuse or breaking of conductor in only one phase) is known as single phasing condition.
- If the 3-phase induction motor continuous to run on single phasing condition,
- **1. Draws more current from remaining two phases (nearly 2 times the earlier current).**



- **2. Torque developed is reduced.**
- **3. There will be severe vibrations and phase windings will get heated.**
- **4. The rotor gets heated due to unbalance currents. This excess heating of rotor and stator will produce noise, heat and smoke.**
- Hence, to avoid above draw backs a single phasing preventer is connected in the supply circuit.
- The single phase preventer consists of phase failure relay which detects the single phasing condition and trips the circuit-breaker or contactor in the motor control circuit.
- The energy meter is not required for agricultural purpose as the tariff is slab system.

### **22 SUBMERSIBLE IRRIGATION PUMP SET**

- A submersible pump is a unit combining a pump and a motor to an enclosed unit.
- It is a particular type of centrifugal pump designed to function with the pump and the motor. As the name indicates, it works under water.
- The pumps are specially designed to be submerged in a liquid and fitted with completely sealed and waterproof motor.
- The whole assembly is vertically submerged under water in a borehole and driven by electricity to pump the water.
- The power to the motor is fed through one or more flexible watertight cables. It pushes groundwater to the surface for irrigation purpose.
- Most submersible pumps are long cylinders that are about 3 to 5 inches around and 2 to 4 feet long.
- Submersible water pumps have a hermetically sealed motor that is close-coupled to the body of the water pump.
- Having a hermetically sealed motor prevents the water from getting inside the pumps motor and causing a short circuit.
- Other components of a submersible water pump are the cable, which is connected to the motor, and a pipe that transports the water to the surface of the well.



## UNIT – III

### Estimation of Overhead Lines and Earthing

#### INTRODUCTION

- It is well known that the electrical energy is generated in generating stations at a voltage of 3.3 kV, 6.6 kV or 11 kV.
- The voltage is stepped up to high voltage (such as 220/400 kV) at the generating (sending) end and transmitted over a long distances to the major load centers where it is stepped down to low voltages (such as 132/66/33 kV).
- This voltage is further stepped down to 11 kV at sub-stations and finally stepped down to 400/230 V.
- This voltage is distributed to various small and big consumers by means of distribution network.
- The overhead lines which convey the electrical energy from generating stations to the sub-stations are known as overhead (O.H) lines.
- These are also called as Feeders, —In our country 3-phase, 3-wire a.c. system is most commonly adopted for generation and transmission of electrical power, where as 3-phase, 4-wire a.c. system is adopted for distribution system through overhead lines.
- The voltage variations should be within at the prescribed limits which are + 5 % in case of L.T (Low Tension) voltage and + 12.5 % in case of H.T (High Tension) voltage.

#### 1. MAIN COMPONENTS OF OVERHEAD LINES

The effective and efficient operation of O.H Transmission lines depends on the mechanical design of the line. In general the main components of an overhead line are. —

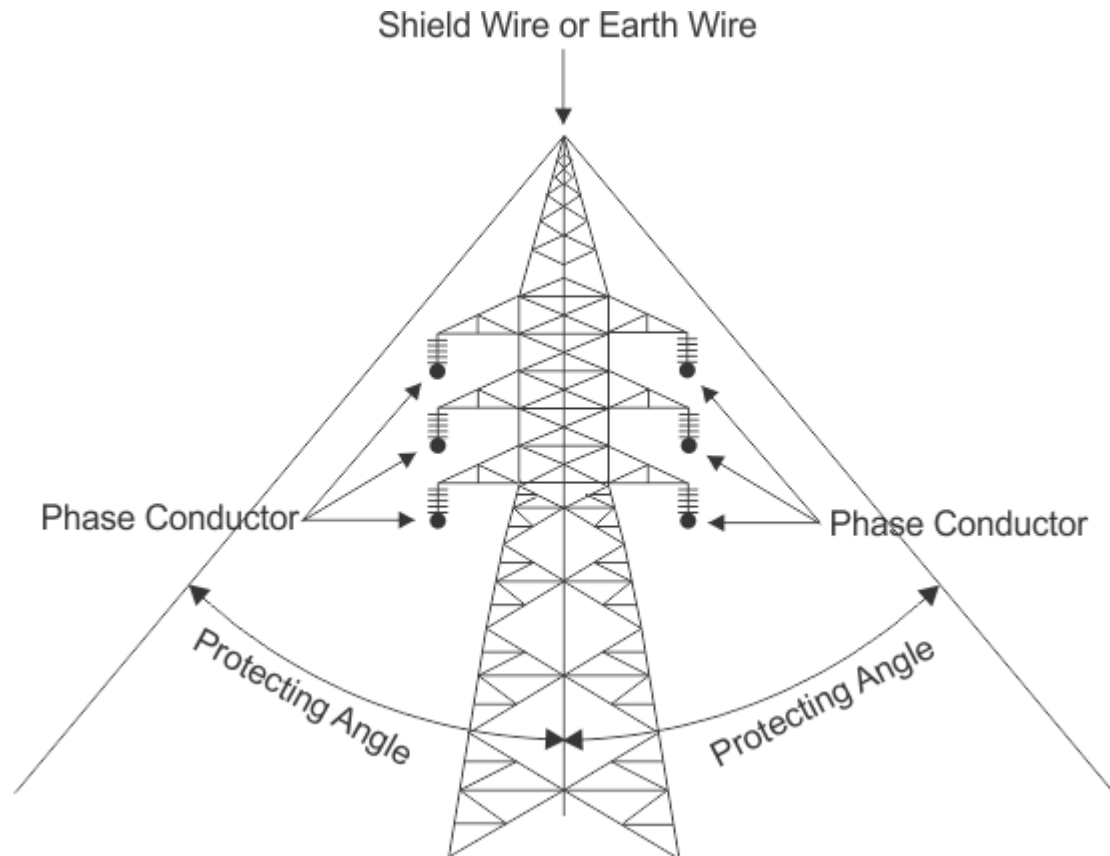
1. Conductors : To carry the electrical power from generating end to receiving end.

2. Supports : These may be poles or towers depending upon the operating voltage and supports the conductors to keep them at a suitable level above the ground level.

3. Insulators : These supports the conductors and insulate them from ground.

4. Cross-arms and Clamps : They may be either wood or steel angle section used to provide support to the insulators and conductors along the poles and are fixed to the supports with the help of clamps.

5. Guys and Stays : These are fastened to the poles at the termination or angle points to resist the lateral forces.



- 6. Lighting Arresters : They discharge high voltage induced on O.H lines to the earth due to lightning.
- 7. Fuses and Isolators : They isolate different parts of the O.H. lines.
- 8. Earth Wire : It is run on the top of the tower to provide protection to the O.H. line against lightning strokes,
- 9. Vee Guards : These are provided below the O.H. lines running along or across streets for protection of human being in case of broken conductors.
- 10. Guard Wires : These are provided above or below the power lines while crossing a communication lines.
- 11. Barbed Wire or Anti-climbing Device : It is provided on each pole at a height of 2.5 m from ground level to prevent climbing of unauthorized persons.
- 12. Danger Plates : These are provided at a height of 2.5 m from ground level and indicate working voltage. A word “danger” is written on the danger plate.
- 13. Phase Plate : These indicate the various phases such as R, Y, B or N etc.
- 14. Bird Guards : A wooden or ebonite piece which is fitted on the cross-arm brackets in case of metallic poles to avoid short-circuiting of two phases or one phase and earth due to sitting of bird on the pole. |
- 15. Miscellaneous Items : Jumpers, bolt and nuts etc.

### 2. Conductors

- The conductor is one of the most important items in transmission and distribution system of electric power.

## Electrical Installation and Estimation (EE3105PE)

- Most of the capital cost is invested on it. Hence, proper choice of material and size of the conductor is utmost importance.
- All conductors used for O.H lines are preferably stranded to increase the flexibility.
- Generally in a stranded conductors, there is one central wire and around this, there is a successive layers of wires containing 6, 12, 18, 24 wires i.e. if there are 'n' layers, the number of individual wires are  $3n(n+1)+1$ .
- The commonly used materials as O.H. lines are copper, All Aluminium stranded conductors (AAC or AASC), Aluminium conductor Steel Reinforced (ACSR),galvanized steel and cadmium copper.
- But Aluminium Conductor Steel Reinforced conductrs are most commonly used as transmission and distribution lines. ACSR consists of galvanized steel which is surrounded by number of aluminium strands.
- ACSR conductors being of high tensile strength and lighter in weight produces small sag and hence longer spans can be used.
- The size of conductor depends on many factors such as working voltage, length of transmission lines, power to be Stranded Conductor carried, power factor of the load and permissible voltage drop.
- The actual length of conductor = length of the line + 2% for sag + 2% as wastage.
- **The size and current rating for a ACSR conductor for O.H line is as follows,**

S.No.	Number and Diameter of wire in mm	Approximate current carrying capacity in Amps. at 45°C
1.	$\frac{6}{1 \times 2.11} \left( \frac{7}{2.11} \right)$	115
2.	$\frac{6}{1 \times 2.36} \left( \frac{7}{2.36} \right)$	133
3.	$\frac{6}{1 \times 2.59} \left( \frac{7}{2.59} \right)$	150
4.	$\frac{6}{1 \times 3.00} \left( \frac{7}{3.00} \right)$	181
5.	$\frac{6}{1 \times 3.55} \left( \frac{7}{3.55} \right)$	208

### 2.1 Supports

- The various types of poles and towers which support the O.H. line conductor are called as supports.
- Line supports must be capable of withstanding the weight of conductor, |wind and ice loads etc.
- The various types of supports used for transmission and distribution of electrical power are :
  1. Wooden poles
  2. Steel tubular poles
  3. Reinforced Cement Concrete (R.C.C) poles

4. Pre Stressed Cement Concrete (P.S.C.C) poles and
5. Lattice steel towers.

The choice of line supports for a particular case depends upon the line span, cross sectional area, line voltage, cost and local conditions.

In normal soil the length of pole to be buried in the ground is one-sixth  $1/6$ " of the pole length.

The normal length of the supports may be 8 meters to 12 meters as shown in Fig. (a).

### H-Type Structure :

Generally single poles are used in the straight runs of an O.H. line.

H-type structure as shown in Fig. (b) is employed in the line at turning points, angle points ( $90^\circ$  or any angle), at dead ends.

Some time in order to achieve line stable, H-type structure is provided after every one kilo-meter in a straight run.

## **2. INSULATORS**

The function of Insulator is to provide insulation resistance for the leakage current from O.H. line to support or earth.

Insulators are mounted on the Cross-arms (also written as X-arms) and the conductors are fixed to the insulators by means of binding wire.

The various materials used for insulators are porcelain, glass, steatite and special artificial materials.

The various types of insulators used for O.H. transmission and distribution lines are.

1. Pin type insulators.
2. Suspension type insulators.
3. Strain insulators.
4. Shackle insulators.

### **Pin Type Insulator :**

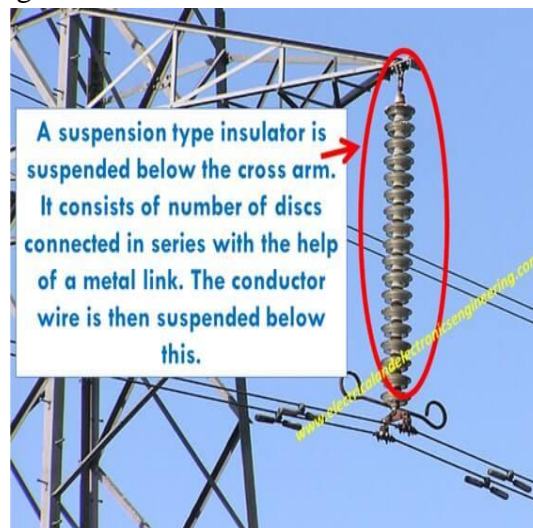
- As the name indicates, this is designed to be mounted on a pin which in turn is secured to the cross-arm of the pole.
- There is a groove at the top of the insulator and conductor passes through this groove and is bound by the aluminium binding wire as shown in Fig. 3.3.
- This type of insulator is used upto 33 kV.

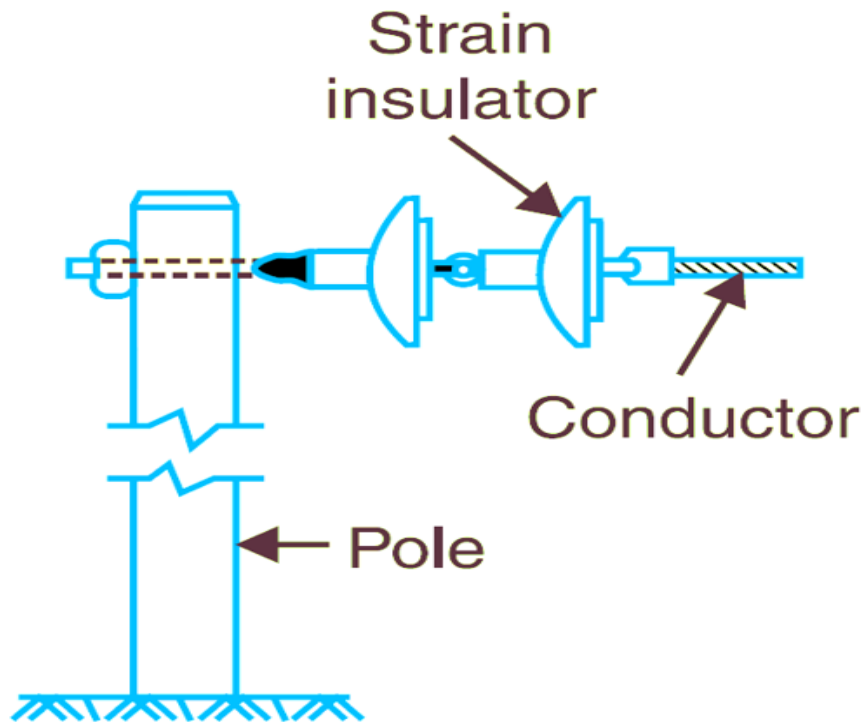




### 2. Suspension Type Insulator :

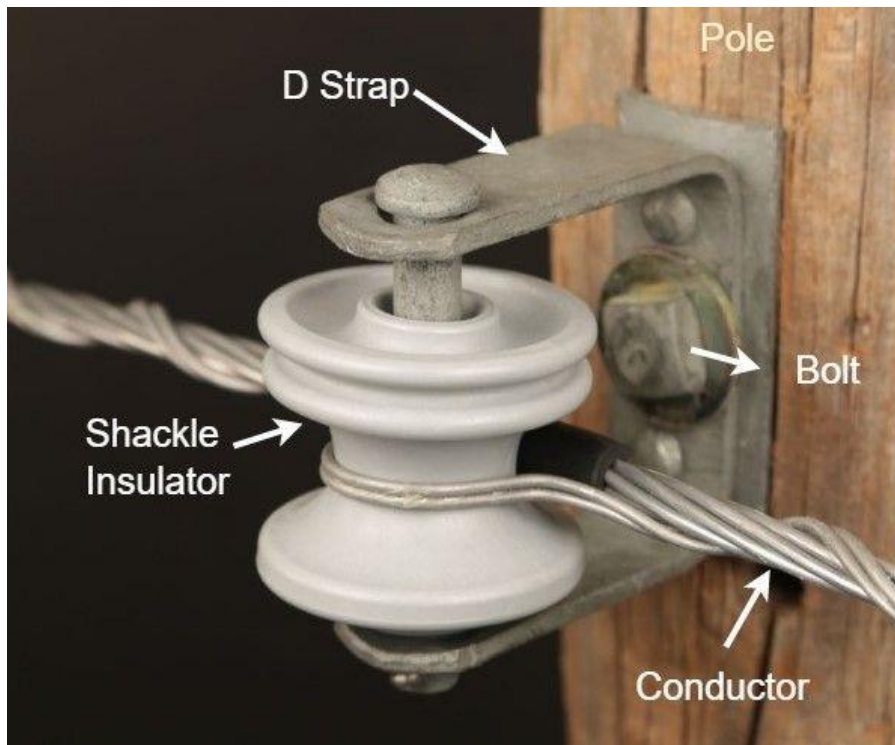
- This type of insulator consists of a number of discs connected in series by metal link in the form of a string.
- The conductor is suspended at the bottom of the string and other end is fixed to the X-arm as shown in Fig. 3.4.





#### 4.Shackle Insulator :

- Shackle insulator can be used either in a horizontal position or vertical] position.
- These are directly fitted to the pole or cross-arm with a bolt and nut as shown in Fig.3.6.
- The conductor is fixed in grooves by means of soft copper or aluminium -binding wire.

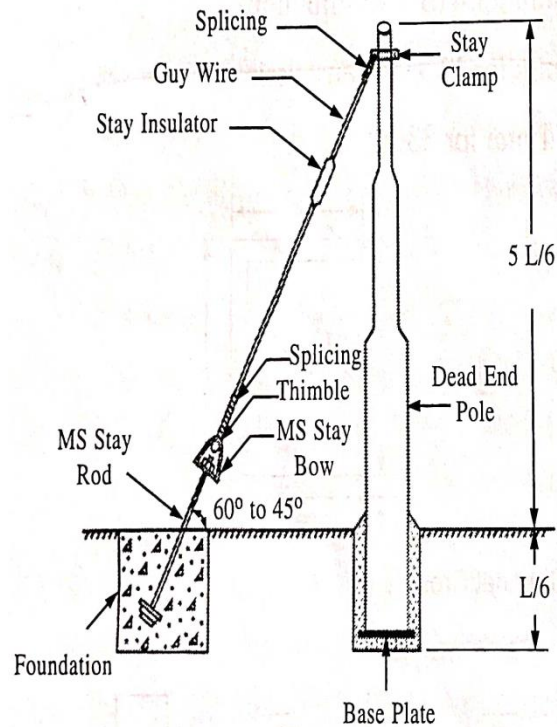


### 4. CROSS - ARMS AND CLAMPS

- The function of cross-arm is to support insulators, and to keep the conductors at a safe distance from each other and from the pole.
- These are fitted at the top of the pole by means of clamps.
- The most commonly used cross-arms are Mild Steel (M.S) channel or angle iron and may be of straight, U-shaped, V-shaped or zig-zag shaped as shown in Fig. 3.8.
- The commonly used sizes of Mild Steel channel for different voltages are as follows.

### 5 GUYS AND STAYS

- It is necessary to support the poles when conductors run at an angle or at terminal points so that pull created by overhead line is balanced. The wire tied between pole and stay tightner is called “Guy wire”.
- The stay rod is well set in ground in concrete foundation before the line conductors are stretched on poles.
- Guy wire is fixed to the pole by means of clamp and then guy wire is tied to stay bow as shown in Fig.,
- The minimum angle between pole and stay is  $30^\circ$ .
- Stay set consists of M.S. rod of 19 mm dia, stay bow, check nut, thimble, stay wire (7/18 or 7/20 S.W.G), Stay clamp and a Cast Iron anchor plate 450 x 450 mm having 4.8 mm hole in the centre.



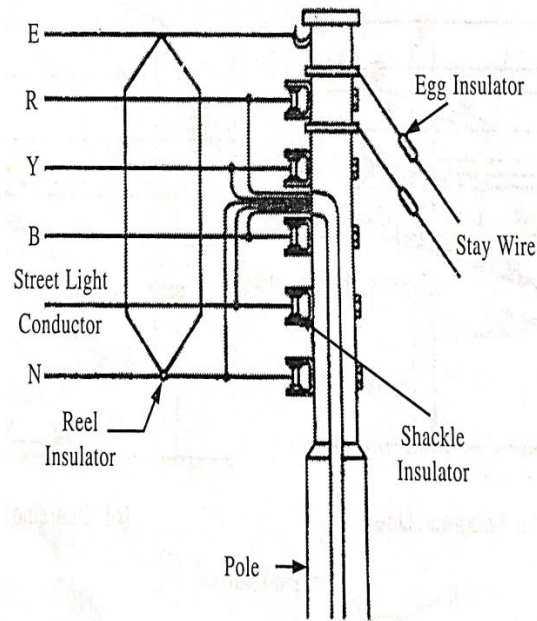
(a) Parts of Stay

### • 5.1 LIGHTNING ARRESTERS

- The lightning Arrester is a device which provide protection to the electrical equipment against lightning surges.
- When a high voltage occurs, lightning arrester provide low impedance path from phase wire to earth and conducts high voltage surge to ground.

### • 5.2 GUARDING OF O.H. LINES

- A guarding is provided for protection of the life, telecommunication lines, safety of road, railway line etc.
- The guarding is provided at road crossings, river crossings, railway crossings, crossing over L.T line or Telecommunication line etc. LE. rule No. 87 provides that every guard wire shall be connected with earth at each point at which electrical continuity is broken. The various types of guard arrangements are shown in Fig



(e) Cage Guard System

- There are two types of guarding systems, namely :
- (i) Cradle guarding system and
- (ii) Cage guarding.
- Cradle guarding is provided when the conductors are in horizontal or delta formation.
- Cage guarding is provided on L.T lines when conductors run in vertical formation.

### 5.3 CLEARANCE OF CONDUCTORS

The minimum clearance of conductors as per LE. rules is given below

S.No	Type of Overhead line	Minimum clearance between conductor and ground in meters.			Clearance from building in meters	
		Across the road	Along the road	At any place	Vertical clearance	Horizontal clearance
1	Low (250 V), Medium (650 V) Voltage	5.8	5.5	4.6	2.5	1.25
2.	High Voltage upto 11 kV	6.1	5.8	5.2	3.66	1.25
3.	High voltage above 11 kV upto 33 kV	6.1	5.8	5.2	3.66	1.83

Note :

- (i) For extra high voltage lines, the clearance above the ground shall not be less than 5.2 m plus 0.3 m for every 33 kV.
- (ii) The minimum clearance along or across any street shall not be less than 6.1 m.



### 6. STEPS TO SOLVE PROBLEMS ON ESTIMATION OF O.H. LINES

The following steps will help in solving the problems on O.H. lines.

**Step-1 ; Determination of No. of Spans :** The number of spans can be calculated by using the following formula.

No. of spans = Length of the transmission line / average span

**Step-2 : Determination of No. of Poles :** Number of poles is always one more than number of spans. Hence, No. of poles = No. of spans + 1 For double pole structure (H-type structure) it requires two poles.

**Step-3 : Determination of Length of Conductor :** Length of conductor = length of line  $\times$   $n + 4\%$  for sag and wastage.

Where 'n' = Number of conductors = 2 for 1-phase system

= 3 for 3-phase system

= 4 for 3-phase, 4-wire system

= 5 for 3-phase, 5-wire system

**Step-4 : Determination of No. of Insulators :** Pin type insulators are required for straight run and shackle/strain insulators are required for the poles at dead end or cut points. Number of insulators depends on type of system and No. of poles. ‘

- **Step-5 : Determination of No. of Cross-arms :** Generally each pole is fitted with one cross-arm. If there is a sudden diversion, two cross-arms may be used for that pole.
- **Step-6 : Determination of G.I. Wire/G.S. (Galvanized Steel) Wire :** 8 S.W.G. G.I./G.S. wire is used for earth wire, guards and for earthing. Total length of earth wire depends on total length of the line, number of earth points to be provided. Earth — wire is passed over the transmission line.
- **Step-7 : Determination of Stay Sets & Earth Sets :** Generally two stay sets are provided for dead end poles and cut-point poles and one for every fifth pole. One earth set is provided for every fifth pole. 1
- **Step-8 : Schedule of Materials :** The quantity of materials required is prepared in the following table.

### 7. ESTIMATION OF POLE MOUNTED AND PLINTH MOUNTED SUB – STATIONS

- In the present-day, electrical power is generated, transmitted and distributed in the form of alternating current.



## Electrical Installation and Estimation (EE3105PE)

---

- The electrical energy is generated at low voltage (such as e.6:08 11 kV) but is stepped up to high voltage (such as 220 or 400 kV) for transmission.
- But the consumers do not use high voltage, hence the voltage must be stepped down to low voltage (400/230 V).
- The place where stepping up and stepping down of voltage is done is known as “Sub-Station”.

### 1.SUB-STATION

- The assembly of apparatus used to change some electrical characteristics (such as voltage, frequency, a.c. to d.c, power factor etc.,) of electrical energy is known as “Sub-Station”.
- The Sub-station may perform any one or two or all of the following operations.
- 1.Switching Operation : To switch ON and OFF the power line.
- 2.Voltage Transformation Operation : To change voltage from high level to lowlevel or vice-versa.
- 3.Power Converting Operation : To change a.c. power into d.c. power andvice-versa.
- 4.Frequency Changing Operation : To change the supply frequency level i.e.from high level to low level or vice-versa.
- 5.Power Factor Correction Operation : To improve the power factor of the system using static capacitors, synchronous condensers or phase advancers.

### 2. CLASSIFICATIONS OF SUB-STATIONS

- The Sub-stations can be classified in several ways. The two important ways of classifying the sub-stations are as follows.
- 1. According to Service Requirement : In accordance with the service performed, sub-stations are classified as,
  - i. Switching sub-stations
  - ii. Transformer sub-stations.
  - iii. Power factor correction sub-stations.
  - iv. Frequency changer sub-stations.
  - v. Converting sub-stations.
  - vi. Industrial sub-stations.

## Electrical Installation and Estimation (EE3105PE)

---

- According to Design or constructional Features :
- In accordance with design (constructional features) sub-stations are classified as
  - i. Indoor sub-stations.
  - ii. Outdoor sub-stations.

### 8 MAIN COMPONENTS OF POLE OR PLINTH MOUNTED SUB – STATIONS

- The following are the major components of 11 kV/400 V Pole or Plinth mounted sub-stations,
- **1. Poles :** The poles may be of steel or PSCC type having a length about 8 m to 12 m. In pole mounted sub-stations the transformer is erected on Mild Steel channel of (H-type or 4-pole structure).
- **2. Plinth :** Transformers of capacity more than 250 kVA are placed on a plinth. The plinth is constructed with bricks or stones.
- **3. Transformer :** It is generally called as distribution transformer. It is a 11 kV/400 V step-down transformer.
- **4. Insulators :** Generally this sub-station is located at dead end of 11 kV line, hence 11kV disc insulators are used to connect 11 kV line.
- **5. Cross-arms :** Different sizes of Mild Steel cross-arms are used to erect Disc insulators, Gang Operating Switch, Horn Gap (H.G) fuse etc.
- **6. Fuses :** Horn Gap (H.G) fuses are provided on 11kV (H.T) side, where as open type rewirable fuses are used on 400V (L.T) side.
- **7. Gang Operating Switch (G.O.S) or Air Break (A.B) Switch :** It is used to switch \_ON & OFF 11kv line.
- **8. 31/2 Core Cable :** The output of distribution transformer is connected to L.T line - through 31/2 core Aluminium conductor armoured 1100V grade PVC cable.
- **9. Stays :** At least 2 stay sets are provided to support poles.
- **10. Distribution Boxes :** The L.T supply of distribution transformer is fed through distribution box which consists of fuse unit.
- **11. Jumpers :** These are used to connect 11 kV lines. Generally ACSR conductor is used for this purpose .
- **12. Barbed Wire (Anti-climbing Device) :** It is provided on the poles at a height of about 1.5 m to prevent the climbing of unauthorized persons.

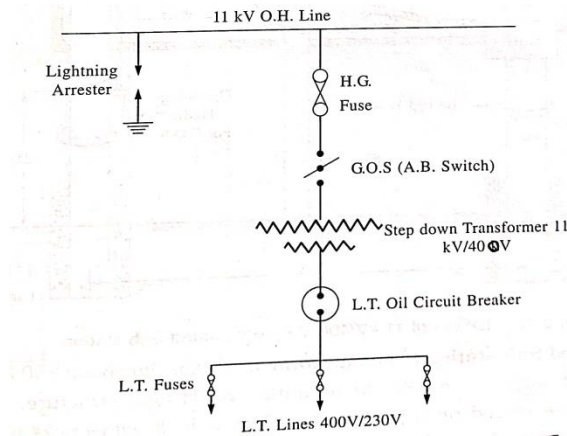
## Electrical Installation and Estimation (EE3105PE)

---

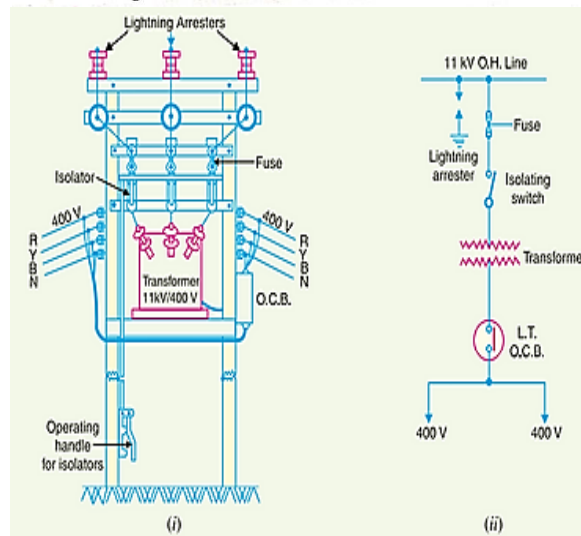
- **13. Fencing :** It is provided around the Poles/Plinth to prevent the entry of animals — or children.
- **14. Earthing Sets :** In order to achieve effective earthing this type of sub-station earthed at two or more places.
- **15. Lightning Arresters :** These are provided on 11 kV line to protect the transformer from lightning surges or strokes.
- **16. Danger Plates :** These are provided On each pole and a word “: : Danger” is written on it. This means that the unauthorized Persons are not supposed to enter in sub-station.

### 9 CONSTRUCTION DETAILS OF POLE AND PLINTH MOUNTED SUB – STATIONS

- In this type of sub-station all the equipment is exposed to atmosphere
- **1. Pole Mounted Sub-station :**
- This type of sub-stations are erected for distribution of power in localities.
- As the name indicates, in this type of sub-station, the transformers upto a capacity of **250 kVA (such as 25, 63, 100, 125, 200, 250etc.,) are placed on H-type structure or 4-pole structure** with a suitable platforms.
- These are cheap, simple and smaller in size. The transformer is of step-down type, which **step-downs 11 kV into 400/230 V.**
- A Gang Operating Switch (also called as Air Break switch) is used for switching ON & OFF of H.T (11 kV) line.
- Horn Gap (H.G) fuse unit is installed for protection of H.T side of transformer against high currents, where as L.T side is protected with L.T fuse unit.
- Lightning Arresters are installed over the H.T line to provide protection of transformer against the surges. The sub-station is earthed at two or more places.
- The oil circuit breaker (O.C.B) installed in the L.T side automatically cuts off the transformer from the consumers in the event of any fault.
- Fig.1 shows the schematic diagram and Fig. 2 shows the layout of Pole-mounted sub-station.

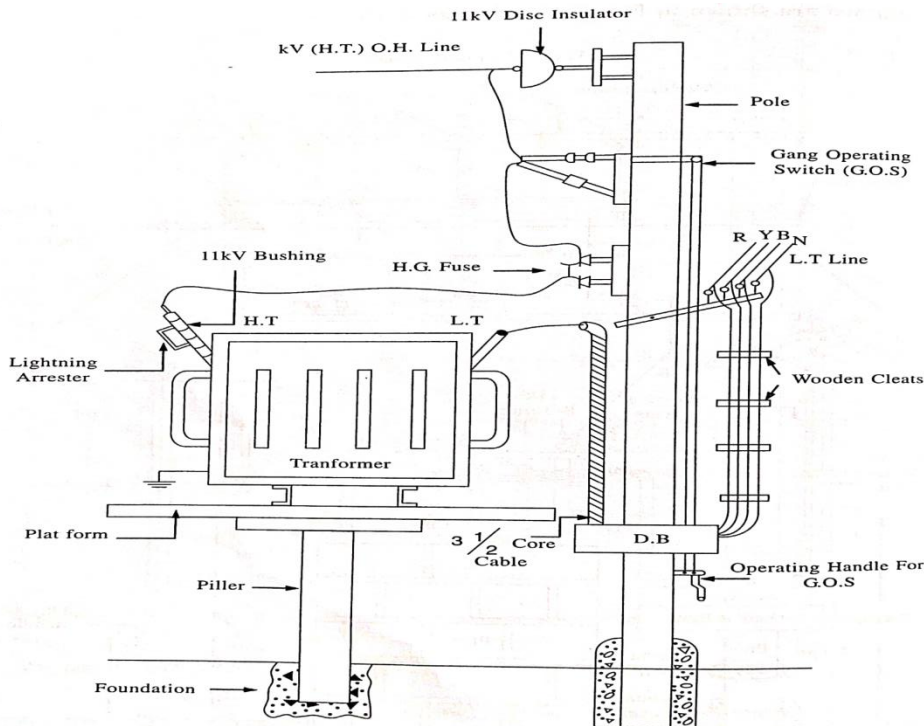


**Fig 1** Schematic Diagram of Pole-mounted Sub-station



### 2. Plinth Mounted Sub-station :

- The transformers of capacity above 250 kVA are heavy in weight and will not suitable for mounting on H-type structure.
- Hence, such transformers are placed on a plinth. The plinth is built with bricks or stones with cement concrete and transformer is located on a plinth, hence the name Plinth mounted sub-station.
- It is also called as Foundation mounted sub-station.
- All the equipments and accessories are arranged on a L.T pole.
- Some times two poles to be used for feeding two L.T lines.. The different views of layouts of Plinth Fig.



### 11 EARTHING

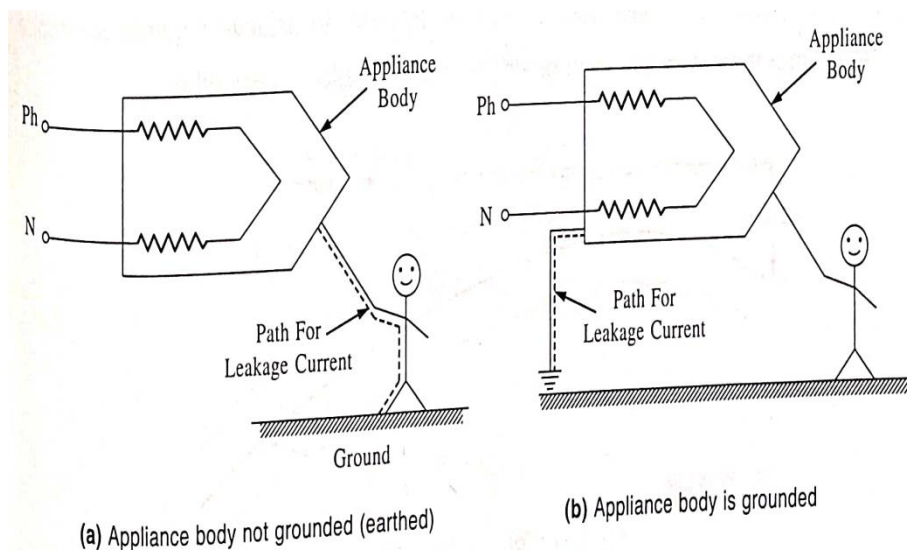
- Earthing means the direct connection of the non-current carrying parts of electrical equipments such as metallic frame work, electric motor body, metallic covering of cables, earth terminal of socket outlet, transmission tower etc to earth (ground) is known as “Earthing or (Grounding)”.
- The Earthing is done by connecting the body of the appliance to earth by employing some good conductor known as Earth wire.
- The rod, wire, pipe or plate embedded in earth for the purpose of making an effective connection with earth is known as Earth electrode.

### 1 PURPOSE/NECESSITY OF EARTHING

- 1. To save human life from electric shock.
- 2. To avoid risk of fire due to earth leakage current through unwanted path.
- 3. To maintain the line voltage constant (since neutral of every alternator, transformer is earthed).
- 4. To ensure that no current carrying conductor rises to a potential with respect to earth than its desired insulation.
- If the appliance is not earthed as shown in Fig. (a).

## Electrical Installation and Estimation (EE3105PE)

- Suppose for any reason if the insulation of the cable damages, then the metallic body of the appliance comes indirect contact with the live wire.
- Now, if a person comes in contact with the metallic body the leakage current will pass through the human body and he will get a severe electric shock.
- But if the metallic body of the appliance is earthed as shown in Fig. (b), the leakage current will transformed to the earth through earth wire instead of passing through the human body.
- This is because, the earth wire (having negligible resistance) is in parallel with the human body (having an average resistance of 50 k-ohm)with respect to earth.
- Hence, leakage current always chooses a low resistance path and flow through the earth wire instead of flowing through the human body. In this way earthing of metallic parts of electrical equipment and appliances provide safety to human being.



### 2 TYPES OF EARTHING

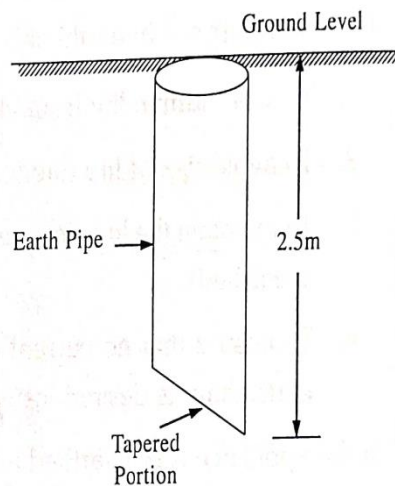
- The various methods of earthing in common use are :
- 1.Rod earthing.
- 2. Strip or Wire earthing.
- 3.Pipe earthing.
- 4, Plate earthing.

Rod Earthing :



## Electrical Installation and Estimation (EE3105PE)

1. In this system of earthing solid rod of 12.5 mm dia of copper or 16 mm dia of solid G.I or steel rod of length not less than 2.5 metre is driven vertically down wards into the earth either by manually or by hammer.
2. Sometimes it is required to drive more than Tapere done rod to reduce the earth resistances to a desired value.
3. This system is cheap and is suitable in areas where the soil is loose or sandy.



### Strip or Wire earthing.

- This system is employed in places, where the soil is rocky, :because in rocky areas the soil excavation work is difficult.
- In this system a wire or strip of cross-section 25 mm x 1.6 mm ( $3.0 \text{ mm}^2$  if round) if of copper or 25 mm x 4mm ( $6.0 \text{ mm}^2$  if round) of G.1 or steel is buried in the ground in horizontal trenches of minimum depth of  $\frac{1}{2}$  meter ( $1\frac{1}{2}$  feet) as shown in Fig.
- The length of the wire or strip depends on the requirement of earth resistance, but the length should not be less than 15 meters.
- In order to achieve required resistance, sometimes more than one wire or strip is laid in parallel to each other,

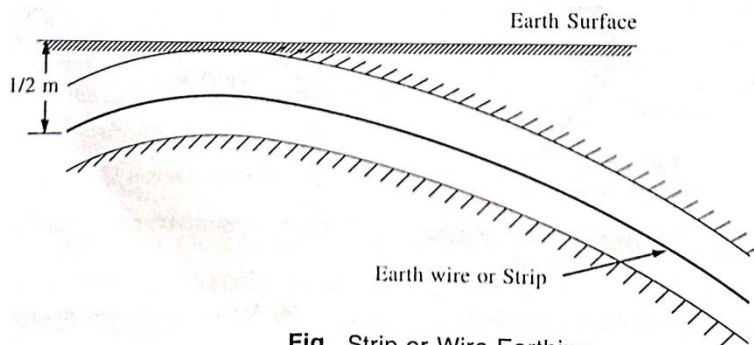


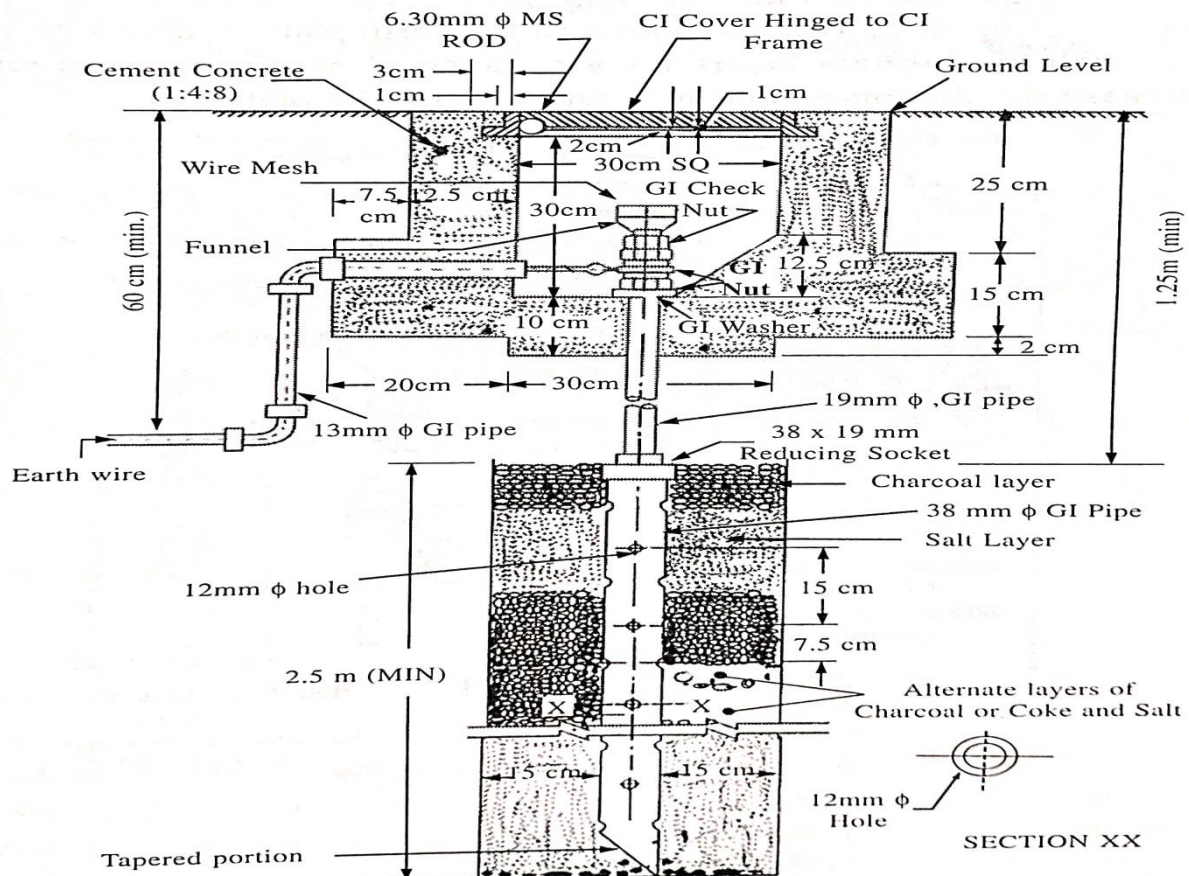
Fig Strip or Wire Earthing

### 3. Pipe Earthing :

- It is a common system of earthing in which a square pit of sides 40 cm each is dug about 4 to 5 meters deep.

## Electrical Installation and Estimation (EE3105PE)

- A G.I. Pipe of 38 mm dia and 2.5 m long is placed vertically in a pit to work as earth electrode.
- The depth at which the pipe is placed depends upon the moisture of the ground, but the pipe is placed at a minimum depth of 3.75 meters.
- The pipe is provided with a tapered casting at the lower end in order to facilitate the driving.
- The pipe in the pit is surrounded by pieces of coke or char coal and salt in alternate layers for a distance of about 15 cm to increase the dampness and moisture around the pipe.
- The pipe has 12 mm dia holes, so that water poured from top is made to spread in the charcoal and salt layers through the holes to decrease earth resistance.

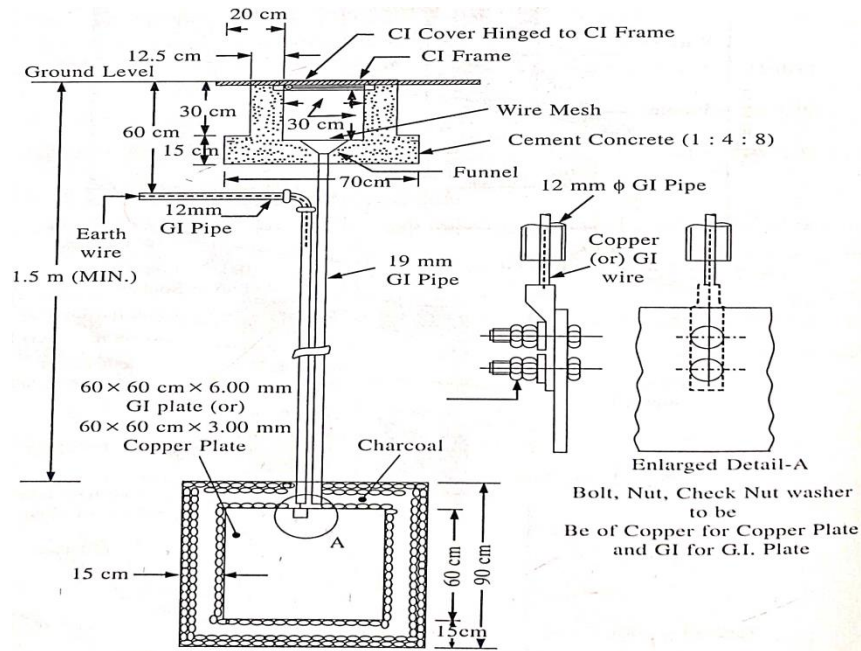


#### 4. Plate Earthing :

In this type of earthing a copper plate of dimension 60 cm x 60 —cm x 3mm or a G.I. plate of dimension 60 cm x 60c m x 6 mm is used as earth electrode.

A pit is dug about 3 meters deep from ground level and earth plate is buried with its face vertical.

The space around the earth plate is filled with coke or charcoal and salt in alternate layers for a distance of about 15 cm around the plate to increase the dampness and moisture around the plate.



### 12. SELECTION OF EARTHING

- The type of earthing to be provided depends on many factors such as type of soil, type of installation etc.
- Double earthing is necessary for certain important installations in view of two reasons, firstly to give minimum resistance to the flow of leakage current and secondly if one earth is out of order, another earthing will do the work. In case of double earthing two earthings are done at a distance of about 5 meters.
- The following table helps in selecting a type of earthing for a particular

### 13 EARTH RESISTANCE

- The earth resistance should be low enough to cause flow of current to earth.
- The following maximum permissible values of earth resistances will give satisfactory results,
- Large power stations = 0.5 ohm
- Major sub-stations = 1.0 ohm
- Small sub-stations = 2.0 ohm
- In all other cases = 5.0 ohm

### FACTORS AFFECTING EARTH RESISTANCE

- The resistance of earth depends on the following factors.

1. Condition of soil.
2. Moisture content of soil.
3. Temperature of soil.
4. Depth of electrode at which it is embedded.
5. Size and spacing of earth electrode.
6. Material of earth electrode.
7. Quality and Quantity of coal and salt in the earth pit.

### METHODS OF REDUCING EARTH RESISTANCE

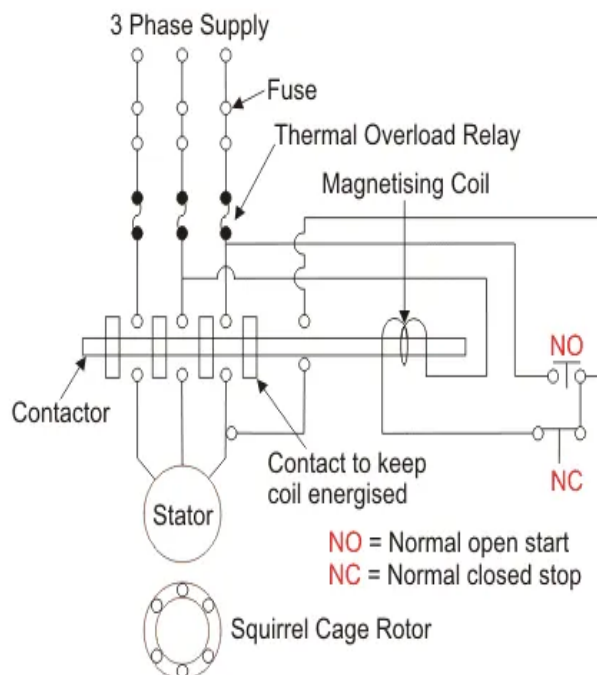
- The earth resistance can be reduced from the following methods.
- 1. By Pouring Water : The water increases the dampness and moisture content of earth which causes in reduction of earth resistance.
- 2. Increase in Cross-sectional Area of Earth Electrode : By increasing the area of earth electrode the earth resistance can be reduced. But the decrease of resistance is not in direct proportional to the area.
- It is found that to reduce the resistance value by one-sixth, the increase in area is 36 times more for the same soil condition and depth of electrode. Hence, this method is not recommended.
- Increase in Depth : The increase in depth below the ground level will reduce resistance of the earth system.
- Electrodes in Parallel ; The earth resistance can be reduced by connecting the number of electrodes in parallel.

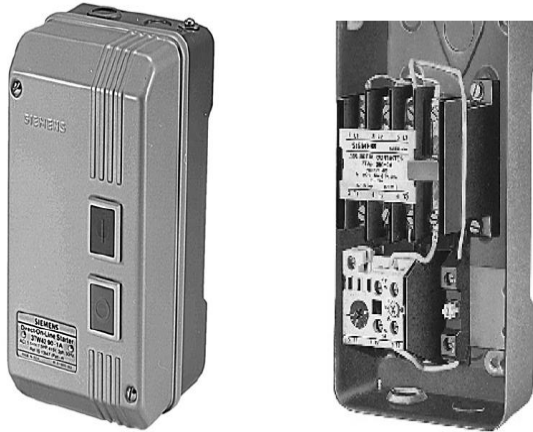
### UNIT - IV

#### Estimating and Costing of Repairs and Maintenance of Electrical Devices and Equipment

##### What is DOL Starter?

- A **DOL starter** (also known as a **direct on line starter** or **across the line starter**) is a method of starting a [3 phase induction motor](#).
- In a DOL Starter, an [induction motor](#) is connected directly across its 3-phase supply, and the DOL starter applies the full line voltage to the motor terminals.
- Despite this direct connection, no harm is done to the [motor](#).
- A DOL motor starter contains protection devices, and in some cases, condition monitoring. A wiring diagram of a DOL starter is shown below:





- Since the DOL starter connects the motor directly to the main supply line, the motor draws a very high [inrush current](#) compared to the full load [current](#) of the motor (up to 5-8 times higher).
- The value of this large current decreases as the motor reaches its rated speed.
- A direct on line starter can only be used in circumstances when the high inrush current of the motor does not cause an excessive voltage drop in the supply circuit.
- If a high voltage drop needs to be avoided, a [star delta starter](#) should be used instead. Direct on line starters are commonly used to start small motors, especially [3 phase squirrel cage induction motors](#).
- As we know, the equation for armature current in the motor.
- At starting, the value of E is zero. So starting current is very high.
- In a small rating motor, the rotor has a more considerable axial length and small diameter. So it gets accelerated fastly.
- Hence, speed increases and thus the value of armature current decreases rapidly.
- Therefore, small rating motors smoothly run when it is connected directly to a 3-phase supply.
- If we connect a large motor directly across 3-phase line, it would not run smoothly and will be damaged, because it does not get accelerated as fast as a smaller motor since it has short axial length and larger diameter more massive rotor.
- However, for large-rated motors, we can use an oil-immersed DOL starter.



## Electrical Installation and Estimation (EE3105PE)

---

- The wiring diagram for a DOL starter is shown below. A direct online starter consists of two buttons, a GREEN button for starting and a RED for stopping purpose of the motor.
- The **DOL starter** comprises an MCCB or [circuit breaker](#), contactor and an overload relay for protection.
- These two buttons, i.e. Green and Red or start and stop buttons control the contacts.
- To start the motor, we close the contact by pushing the Green Button, and the full line [voltage](#) appears to the motor. A contactor can be of 3 poles or 4-poles. Below given contactor is of 4-pole type.
- It contains three NO (normally open) contacts that connect the motor to supply lines, and the fourth contact is “hold on contact” (auxiliary contact) which energizes the contactor coil after the start button is released.
- If any fault occurs, the auxiliary coil gets de-energized, and hence the starter disconnects the motor from supply mains.

### Working principle of a **DOL starter**

- The working principle of a **DOL starter** begins with the connection to the 3-phase main with the motor. The control circuit is connected to any two phases and energized from them only.
- When we press the start button, the current flows through the contactor coil (magnetizing coil) and control circuit also.
- The current energises the contactor coil and leads to close the contacts, and hence 3-phase supply becomes available to the motor.
- If we press the stop button, the current through the contact becomes discontinued, hence supply to the motor will not be available, and the similar thing will happen when the overload relay operates. Since the supply of motor breaks, the machine will come to rest.
- The contactor coil (Magnetizing Coil) gets supply even though we release start button because when we release start button, it will get supply from the primary contacts as illustrated in the diagram of the **Direct Online Starter**.

### **3 Phase Motor Starter with Overload Protection**

- When a motor draws excessive current to meet the load requirements such that this load requirement goes beyond the rated limit, this is known as overload.
- [Thermal overload protection](#) is a type of security when the motor draws over current or excessive current and causes overheating of the equipment.

## Electrical Installation and Estimation (EE3105PE)

---

- Overload is also the type of over current. So overload relays are employed to limit the amount of current drawn.
- But that does not mean that protects the short circuit. Fuse or MCB used in the system protects the over current. Overload protection opens a circuit at relatively low currents that are a little higher than the rating of the motor.
- Overload currents are likely to damage if they persist for a long time, i.e. it will not trip if a high value of current flows for a short period such as starting of the motor.
- We often provide overload protection via an overload relay. Overload relays may be solid-state devices with adjustable trip setting also called as the electronic relay or by interacting with related temperature sensors called as a thermal relay or if only operates for excess current flow then called as a magnetic relay.
- For most motors, the maximum rating of the overload protection device is 125% of the full load ampere rating.
- **Advantages of DOL Starter**
- The advantages of a DOL starter include:
  - Simple and most economical starter.
  - More comfortable to design, operate and control.
  - Provides nearly full starting torque at starting.
  - Easy to understand and troubleshoot.
  - DOL starter connects the supply to the delta winding of the motor.
- **Disadvantages of DOL Starter**
- The disadvantages of a DOL starter include:
  - High starting current (5-8 times of full load current).
  - DOL Starter causes a significant dip in voltage, hence suitable only for small motors.
- **DOL Starter** reduces the lifespan of the machine.
- Mechanically tough.
- Unnecessary high starting torque
- **DOL Starter Applications**
- The applications of DOL starters are primarily motors where a high inrush current does not cause excessive voltage drop in the supply circuit (or where this high voltage drop is acceptable).

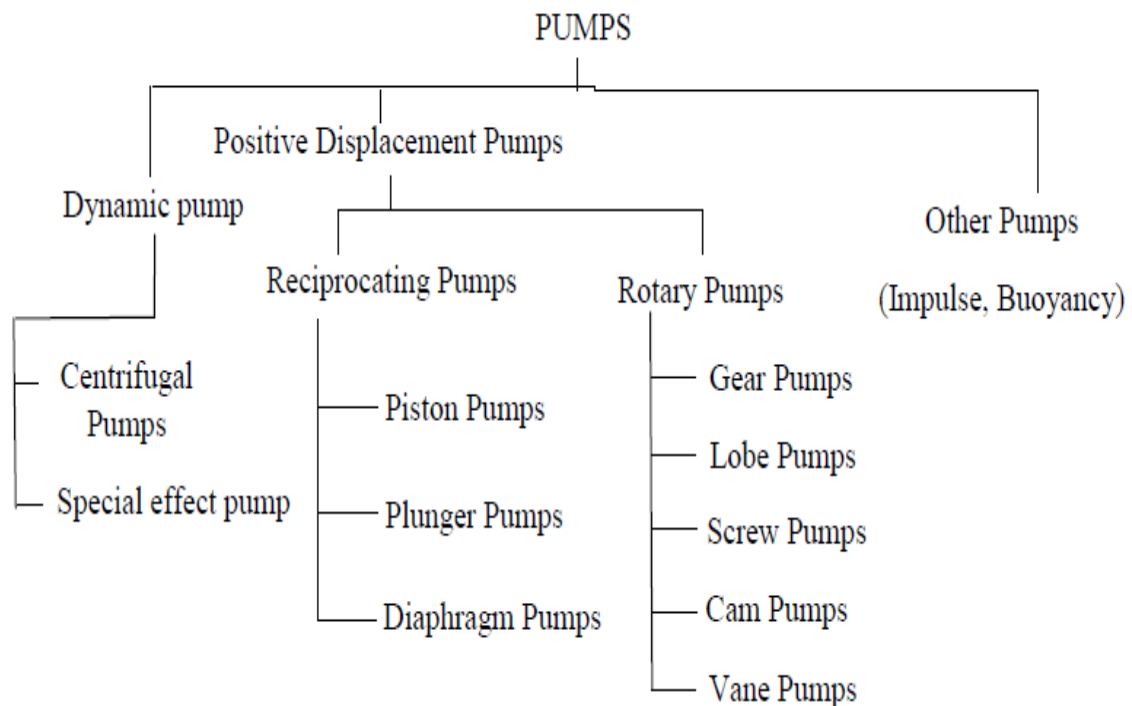
## Electrical Installation and Estimation (EE3105PE)

- Direct on line starters are commonly used to start small water pumps, conveyor belts, fans, and compressors. In the case of an asynchronous motor (such as the 3-phase squirrel-cage motor) the motor will draw a high starting current until it has run up to full speed.

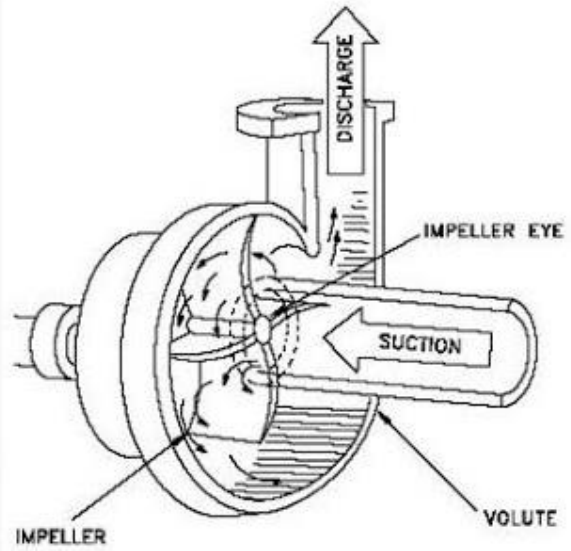
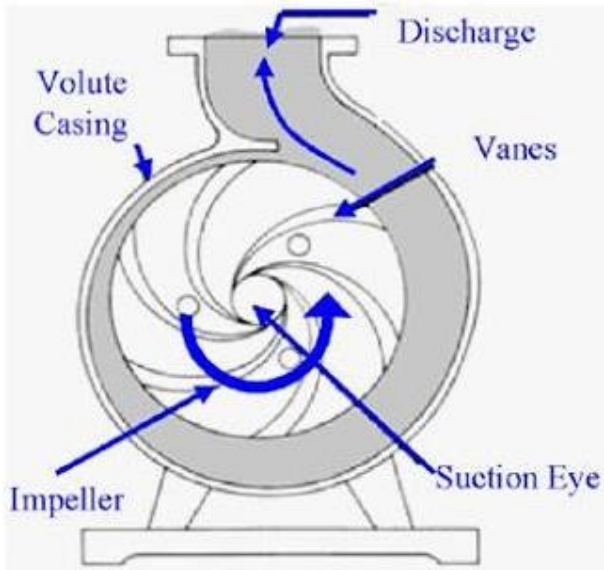
### How does a centrifugal pump work?

- In its simplest form, a centrifugal pump is made from a housing with an inlet and outlet.
- There is an impeller that is located inside the housing, and a motor or drive that is responsible for rotating the impeller.
- The pumps casing (outer shell) is designed to create a gradually widening channel which is known as the volute.
- When the motor (or drive) rotates the impeller it is creating centrifugal force.

### CLASSIFICATION OF PUMPS



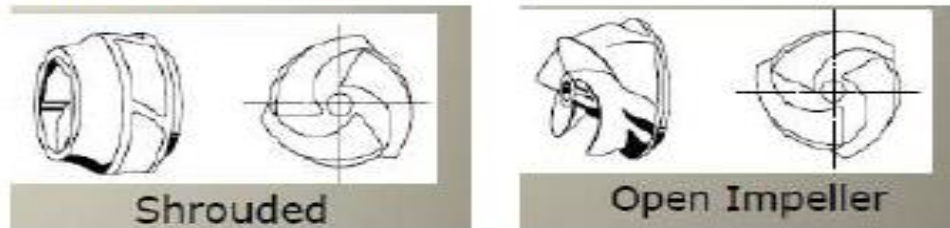
**This force throws the fluid outward to the volute and causes two things to happen:**



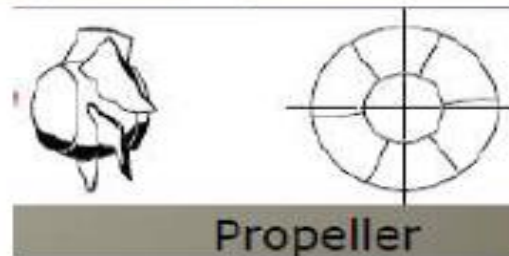
### 1. Radial Flow,



### 2. Mixed Flow,



### 3. Axial Flow



- It creates a reduced pressure area at the eye of the impeller, which acts like a vacuum. This provides a flow of liquid to the pump impeller.

On the other side, the volute causes the fluid to slow down and the pressure inside the pump's housing begins to increase. This increase in pressure forces the liquid out the discharge (outlet) of the pump and then on to the piping systems of the process

### Decide the Type of Pump You Need

- The type of pump you go with depends on where the water supply will be coming from and what kind of output you need. These are the main types of water pumps:
- **Submersible Pumps** – These can be completely submerged in the water of a borewell or an open well.
- **Compressor Pumps** – These are used to move the water where water yield is less and can be used even in loose soil areas.
- **Self-Priming Regenerative Pumps** – Similar to centrifugal pumps, these are also used to lift the water but do not require priming. They can be used for lifting water from a ground tank to an overhead tank.
- **Centrifugal Jet Pumps** – These provide a steady and strong flow of water with the water coming from underground. Depending on the depth, you can get a centrifugal

## Electrical Installation and Estimation (EE3105PE)

---

deep well jet or a shallow well jet pump. These pumps can lift water from > 25 Feet depth.

- **Inline Circulation Pumps** – These pumps are used to circulate hot or cold water within the household. They are generally installed with a water heater to deliver hot water to different parts of the house.
- **Booster Pumps** – When a pressurised flow of water is required, for example in lawns or bathrooms, this type of pump is used.

### Check the Specifications

- Once you have decided the type of pump you want to buy, you will have to look at the specifications. This is an equally important part as your home water pump should be capable of getting a sufficient amount of water with the pressure that you require. Here are some of the specifications you should look at and what they mean:
- **Discharge Rate** – Also known as the flow rate, this is measured in litres per minute (LPM). This will be the amount of water that is pumped within a specific time. The higher it is, the quicker it pumps. A range of 100-200 LPM is usually sufficient for a household.
- **Head Range** – Head here refers to the discharge head – the vertical distance that you will be pumping the water. The head range should fall within this distance for the water pump to pump water effectively. This is measured in meters (m).
- **Power** – This is the amount of electrical power that will be consumed by the pump when in use and it can be measured in kilowatt (kW) and horsepower (HP). This ranges for 0.5-1.5 HP for most pumps with some like inline circulation pump requiring as little as 0.16 HP. This will vary depending on the other specifications of the pump but generally as the amount of water pumped and head range increased, so does the power.

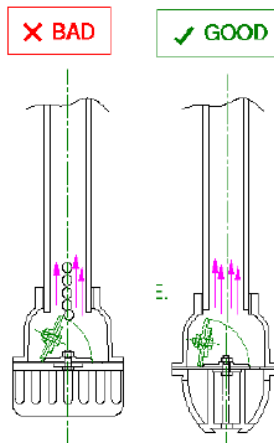
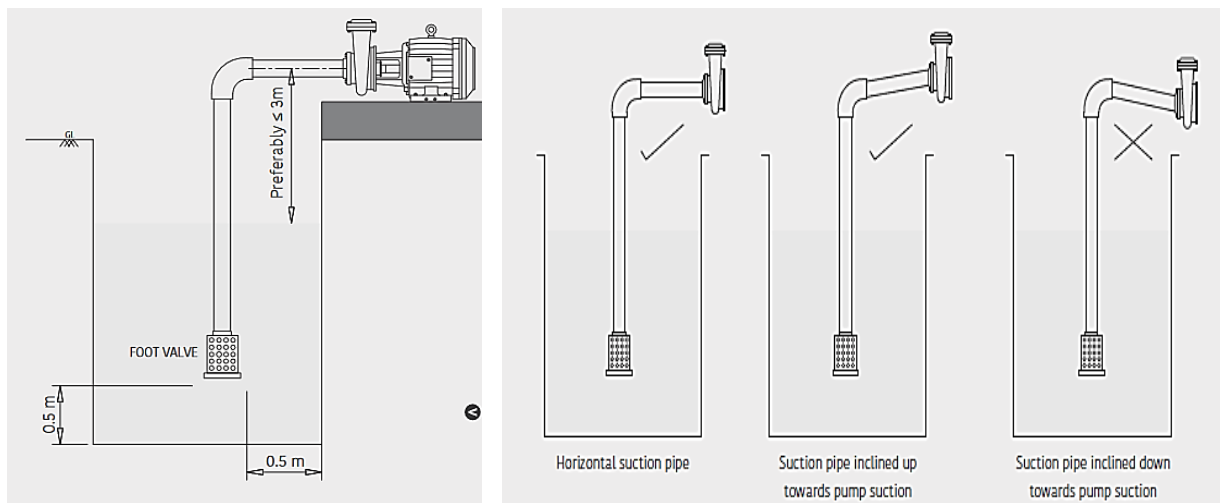
### What are the main parts that make up a centrifugal pump?

- Now that we have an understanding of how centrifugal pumps operate, we can give an overview of its most common parts:
- **Casing (Volute)** – As we learned earlier, this acts as a pressure containment vessel. It directs the flow of liquid in and out of the centrifugal pump. It slows down the speed of the fluid while increasing the pressure within the casing.
- **Impeller** – This is a rotor that is used to increase the kinetic energy of the flow.
- **Motor (drive)** – Power source of the pump. It is responsible for driving the shaft.
- **Shaft (rotor)** – The impeller is mounted on a shaft. This component uses torque from the motor to transfer energy to the impeller.



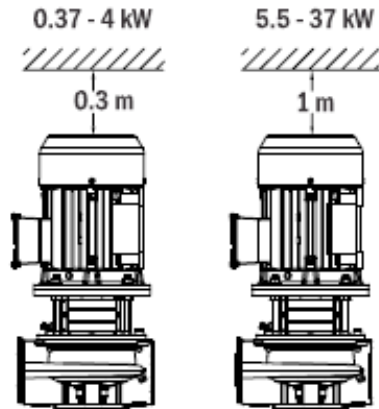
## Electrical Installation and Estimation (EE3105PE)

- **Shaft Seals** – These are packing rings or mechanical seals which help prevent any leakage of the pumped fluid.
- **Bearings** – work to reduce friction between the rotating shaft and the pump and keep the impeller spinning in place.
- Maintenance Programs for centrifugal pumps can be grouped into three categories:
  - routine, quarterly, and annual maintenance.
  - Routine maintenance is the process of setting a schedule to inspect, log, and repair components.
  - This focuses on components that are leading indicator of potential failure.

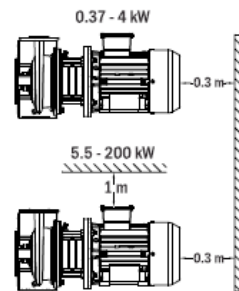


### Vertical installation

- Pumps fitted with motors up to and including 4 kW require a 0.3 m clearance above the motor.
- Pumps fitted with motors of 5.5 kW and up require at least a 1 metre clearance above the motor to allow the use of lifting equipment.



- Horizontal Installation
- Pumps fitted with motors up to and including 4 kW require a 0.3 m clearance behind the motor.
- Pumps fitted with motors of 5.5 kW and up require a 0.3m clearance behind the motor and at least a 1 metre clearance above the motor to allow the use of lifting equipment.
- Mono block pumps with base frame must have the same clearance as pumps with motors from 5.5 kW above.



- **● Bearing And Lubricant Condition**

- ○ Monitor and log bearing temperatures, lubricant level, and vibration. Lubricant should be clear with no signs of bubbling. If bubbling is occurring, this is a good indication to add more lubricant to decrease the temperature of the bearings. If there is an increase in vibration in the bearings, this may be a good indicator of impending bearing failure.

- **● Shaft Seal Condition**

- ○ Check the mechanical seals. There should be no signs of visible leakage.
- ○ During downtime, inspect the pump's packing to make sure there is adequate lubrication. If the packing looks compressed and dry, replace the packing and add lubricant per the operation manual.

- **● Overall Pump Vibration**

- ○ Imminent pump failure can be detected by monitoring overall pump vibration. Excessive vibration can result from a change in pump alignment, bearing failures, cavitation, and obstructions in the suction and discharge lines.

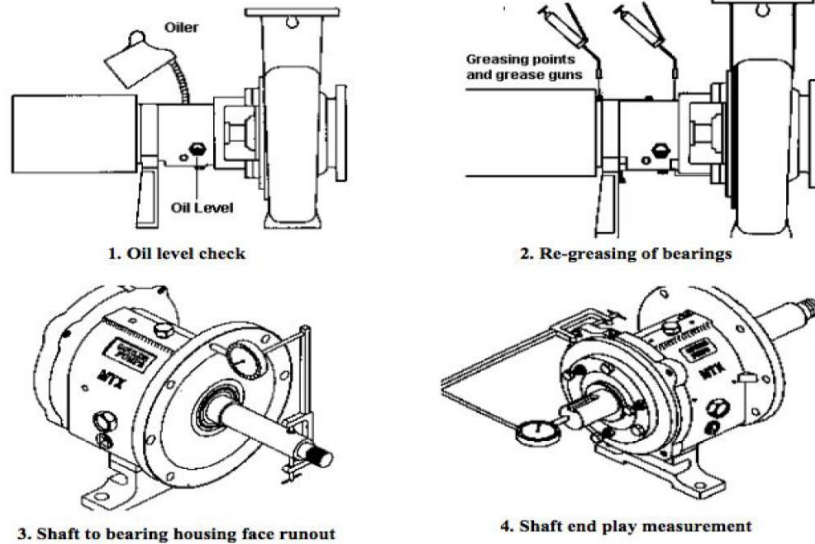
- **● Pump Discharge Pressure**

## Electrical Installation and Estimation (EE3105PE)

- The difference in pressure read by the suction and discharge gauges will provide the total developed head pressure of the pump. Confirm this reading is within the pump's designed performance. You can find this on the manufactured website or your operation manuals..

### Routine Maintenance

#### Illustration of Maintenance Checks<sup>1</sup>



<sup>1</sup> Pictures courtesy of Goulds Pumps Copyright Elfer, Inc. 1998, Waterford, New York

### Quarterly Maintenance

- Verify the integrity of the pump's foundation and check the hold-down bolts for tightness.
- For oil-lubricated pumps, as a rule of thumb, you should change the oil after the first 200 hours of operation for a new pump.
- Then again after every three months or 2,000 operating hours, whichever comes first. Your operation manual will have specific instructions for oil change intervals and oil grade.
- For grease-lubricated pumps, as a rule of thumb bearings should be greased every three months or 2,000 operating hours, whichever comes first.
- Your operation manual should have specific instructions for grease intervals and grease grade to be used.
- Grease the motor bearings according to the manufacturer's instructions.
- Check the shaft alignment.
- Bearing vibration spectrum on all pump and motor bearings.

### Annual Maintenance

## Electrical Installation and Estimation (EE3105PE)

---

- **Bearing Frame And Foot** – inspect for cracks, roughness, rust or scale. Machined surfaces should be free of pitting or erosion.
- **Bearing Frame** – inspect all tapped connections for dirt. Clean and chase threads as necessary. Remove all loose or foreign material. Inspect lubrication passages to be sure that they are not blocked.
- **Shaft And Sleeve** – inspect for grooves or pitting. Check bearing fits and shaft runout, and replace the shaft and sleeve if worn or if the shaft runout is greater than 0.002 inches.
- **Casing** – inspect for signs of wear, corrosion or pitting. If wear exceeds a depth of 1/8-inch, the casing should be replaced. Check gasket surfaces for signs of irregularities.
- **Impeller** – inspect the impeller for wear, erosion or corrosion damage. If the vanes are bent or show wear in excess of 1/8-inch deep, replace the impeller.
- **Frame Adapter** – inspect for cracks, warping or corrosion damage and replace if any of these conditions are present.
- **Bearing Housing** – inspect for signs of wear, corrosion, cracks or pits. Replace housings if worn or out of tolerance.
- **Seal Chamber/Stuffing Box Cover** – check for pitting, cracks, erosion or corrosion. Inspect for any wear, scoring or grooves that might be on the chamber face. Replace if worn more than 1/8-inch deep.
- **Shaft** – check the shaft for any evidence of corrosion or wear and straightness. Noting that the maximum total indicator reading (TIR) at the sleeve journal and coupling journal should not exceed 0.002 inches.

Repairs

## Electrical Installation and Estimation (EE3105PE)

Fault	Possible causes	Suggested actions
Pump does not run	No power supply	Check incoming power supply and rectify
	Very low voltage	Operate in the recommended voltage range
	Impeller stuck	Remove the fan cover and rotate fan by hand
	Loose connections	Check the connections
	Fuse blown	Replace fuse
	Pump has been kept for long time	Ensure free rotation of shaft by running the pump idle for a few minutes at least every alternate day
Pump does not discharge water	Faulty foot valve	Check and replace
	Pump not primed	Prime the pump
	Air leakage on the suction side	Check and correct for leakages
	Suction lift too high	Reduce the suction lift
	Foot valve not sufficiently submerged	Lower the foot valve and ensure that the foot valve is submerged at least 1 metre below the free surface of water
	Check valve is jammed	Check and replace
	Motor coil burnt	Rewind the motor
	Low voltage operation	Operate in the recommended voltage range
	The motor starter overload has tripped	Reset the motor starter overload. If it trips again, check the voltage

Fault	Possible causes	Suggested actions
Less discharge from pump	Low voltage operation	Operate in the recommended voltage range
	Wrong direction of rotation	Interchange the supply connections of any two phases
	Static suction lift high	Position the pump within recommended suction lift
	Total head higher than specified head	Ensure delivery head within specified value
	Leakage in pipes	Check the piping system and rectify the faults
	Smaller pipe size used when compared to name plate recommendations	Use recommended size of pipes
	Discharge pipe internally coated with deposits	Clean the pipe
	Foreign bodies lodged in impellers	Check the impellers and remove the foreign bodies
	The valve in the discharge pipe is partly closed / blocked	Check and clean / replace the valves, if necessary
	The Check valve of the pump is partly blocked	Check and clean Check valve. Replace if necessary
	Impeller is worn out	Check and replace
	Leakage in the pipework	Check and repair / replace piping

## Electrical Installation and Estimation (EE3105PE)

Current consumption in excess	Single phasing	Check line fuses / availability of three phase supply
	Voltage too low	Check the voltage
	Defective rotor	Change the rotor
	Rotor rubbing against stator ID due to bend	Check and replace the rotor
	Low system head and therefore higher discharge	Throttle the discharge

Fault	Possible causes	Suggested actions
Pump runs rough and noisy	Bearings worn out	Dismantle and replace worn out bearings
	Pump cavitating due to high suction lift	Reduce static suction lift
	Pump not grouted	Grout the pump
	Rotor shaft is bent resulting in rotor rubbing against stator bore	Replace rotor shaft
	Excessive wear and tear	Check impeller. If excessive, replace impeller
Pump leaks excessively	Gland not adequately tightened	Tighten the gland
	Packing rope and oil seal worn out	Replace packing rope and oil seal
	Volute - yoke gasket / delivery flange gasket damaged	Check and replace gaskets
	Pipe line damaged	Check and replace piping

### Advantages

- These pumps are mainly designed to provide the best possible efficiency.
- These pumps are compact and simple.
- These pumps are self-supporting.
- They don't require extra base plates as well as a coupling for fitting.
- The overall size is less and less complexity while installing.
- They are cost effective.



### Mono Block Pump Applications

- The uses of monoblock pumps include the following.
- These pumps are used for domestic purposes like gardens, apartments, bungalows, small farms, hospitals, hotels, agriculture, and farm-houses.
- The centrifugal mono block pumps are mainly recommended for freshwater as well as fluids which are not chemically violent toward the components of the pump.
- These pumps are mainly used for agriculture, industrial, civil due to their consistency and strength.
- Thus, this is all about Monoblock [pump, types, and applications](#). There are many factors we have to keep in mind while selecting these pumps like head, size of inlet & outlet, discharge rate, and construction material. From the above information, finally, we can conclude that it is the main mover of the pump like the motor & pump are connected jointly in similar housing. So, there is no requiring of any coupling device among the two shafts because the shafts are attached straight.

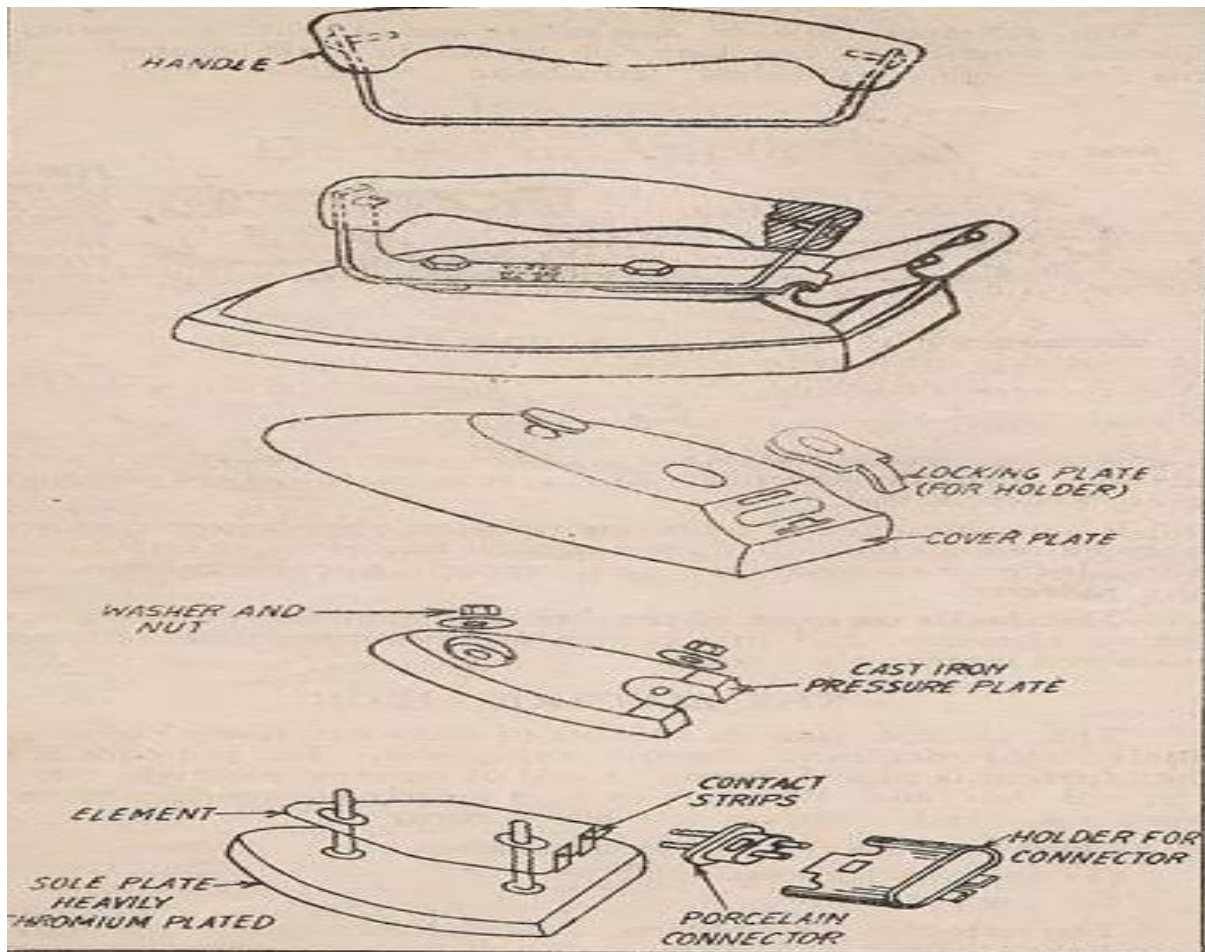
### THE ELECTRIC IRON

- The electric iron has been a FMCG (fast moving consumer goods) product since the 1880s, but as is the case with many modern inventions, it has its roots in history.
- As early as 400 B.C. just like any technology or device the iron box (the modern-day word used to describe a device that is to use to accomplish one task, it was called by different names and with different designs/variants throughout ages and cultures) has faced many many iterations and many design changes to what we see today.
- Let us consider the evolution and design changes throughout history
- Sad iron
  - Box (slug) iron
  - Smoothing iron with removable handle
  - Charcoal iron
  - Charcoal iron with chimney
  - Gas smoothing
  - Petrol iron
  - 1930s electrical flatiron
  - 1960s clothes iron

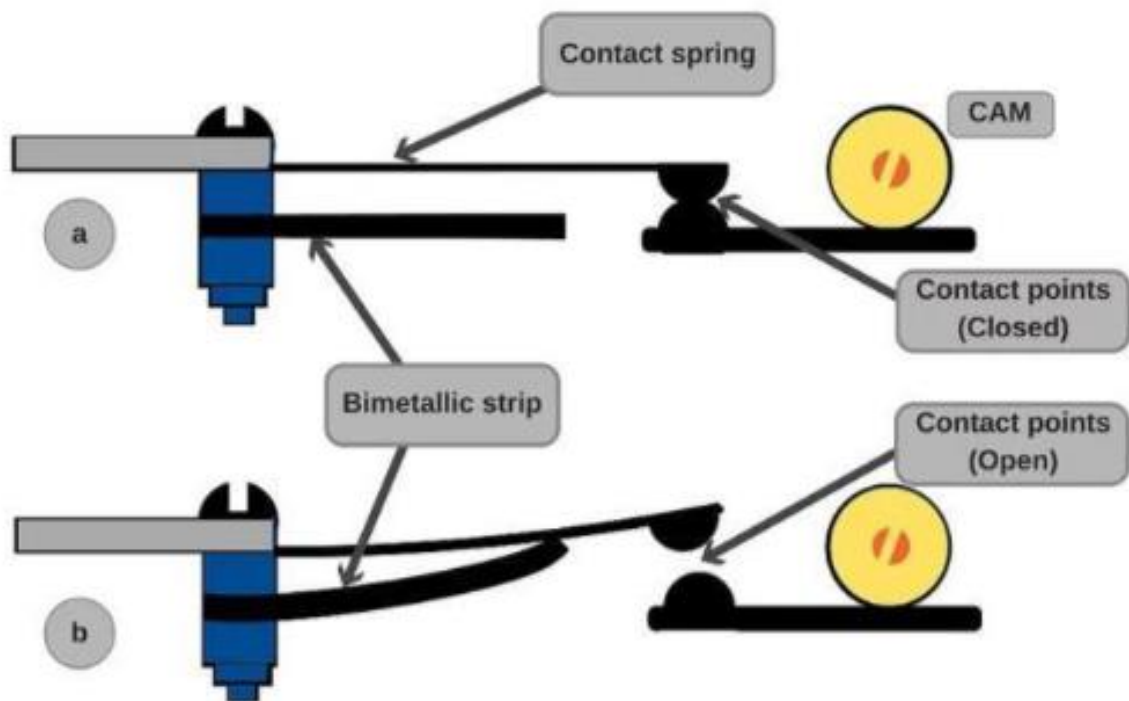
- 1990s Electric steam iron
- Modern wireless iron

### Parts of an Electric Iron

- **Sole Plate**
  - The sole plate is the thick, triangular-shaped slab of iron that forms the base over which the electric iron is built up.
  - The bottom surface and edges are heavily chromium plated, to prevent it from rusting.
  - The base plate should hold the iron pressure plate and cover plate in position.
  - For this purpose we can see two or sometimes three studs in the base plate. These studs aid in holding the position of cover plate and pressure plate.
- **Pressure Plate**
  - This plate is generally called the top plate as it follows the shape of sole plate.
  - The pressure plate has some holes through which the studs from the base plate pass through.
  - We should tighten the nuts on the studs in such a way that the pressure plate and sole plate are pressed tight against each other.
  - In some iron the pressure plate is heavy and made of cast iron while in some other cases, it is a thin sheet of steel, about  $\frac{1}{4}$  cm thick.
  - In automatic type of electric iron, the pressure plate has a rectangular or circular hole for locating the thermostat.



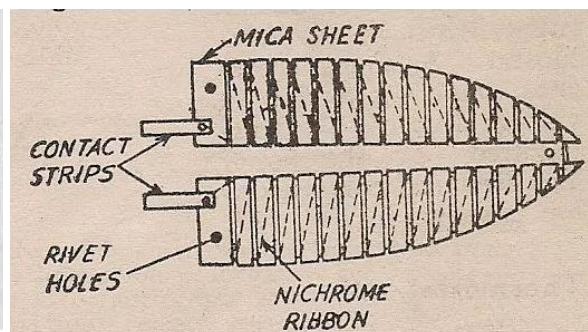
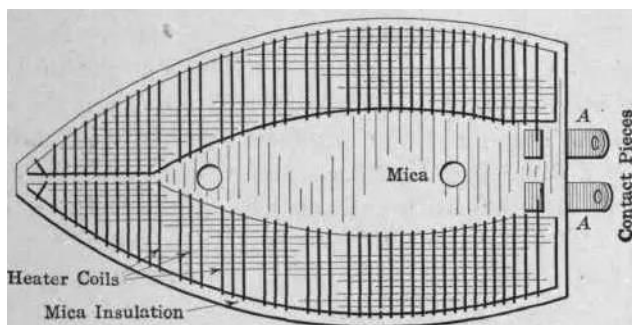
Thermostat



## Electrical Installation and Estimation (EE3105PE)

- Thermostat utilizes a bimetallic strip to govern the switching that is connected in series with the resistance or heating detail.
- The bimetallic strip is a component which converts a temperature variation into mechanical movement.
- A bimetallic strip includes two extraordinary metals fortified together. The 2 metals possess a different coefficient of expansion.
- If any such strip is heated, it starts to curl in the direction of the metal having the lower coefficient of expansion.
- Upon cooling, it straightens out and comes again to the normal function.  
The principal reason of the bimetallic strip is:  
The bimetallic strip is attached to a contact spring through, minute pins. The contact point between the strip and contact factors stays closed. during a surplus temperature variation, the unfamiliar enlargement causes the strip to twist and the touch among strip and make contact with spring opens.
- Consequently, the delivery to the heating element is momentarily paused (till the temperature goes all the way down to a pre-set value primarily based on the cloth selected).
- A tool stated to as the cam is located close to the contact spring, with which we specify the quantity of curving of bimetallic strip required to separate the touching.
- As a consequence, the use of the bimetallic strip, the temperature is stored steady within sure limits.
- The connecting elements, (that determines the degree of bending and straighten) between the knob and the thermistor is also removed.

### The Heating Element



- **The Cover Plate**
- The cover plate is made of thin sheet of iron. It is placed on top of the base plate and it covers all the internal parts of the iron. The handle and connector are only attached to the cover plate.

## Electrical Installation and Estimation (EE3105PE)

---

- **Handle**

- The handle can be made either with wood or with plastic. The handle is attached to the cover plate with the aid of screws. Studs can also be used for this purpose.

- **Pilot Lamp**

- The pilot lamp is housed in the cover plate of the electric iron. One end of the pilot lamp is connected to supply, while the other end is connected to the heating element. A shunt resistance is provided across the pilot lamp which assists in providing a voltage drop. The shunt is designed to provide a voltage drop of 2-5 volts.

### How Can I Identify an Electric Iron Problem?

- As with many small appliances, regular maintenance makes a dramatic difference in how trouble free your electric iron will be. Even so, things can happen.
- If the iron doesn't heat, make sure power is on to the outlet, check the [electrical cord](#), and check the thermostat (see the [Appliance Controls Fix-It Guide](#)) and replace if necessary.
- If the iron heats but steams improperly, inspect the soleplate and clean the vents (see below) and flush sediment out of the steam chamber (see below).
- If the iron produces too much or too little heat, test the [electrical cord](#). Also test and, if needed, adjust calibration of the thermostat (see the [Appliance Controls Fix-It Guide](#)).
- If the iron does not spray properly, inspect and clean the nozzle (see below).
- If the iron leaks or spits, clean the steam vents, nozzle, and tank.
- If the iron sticks to fabric, clean or repair the soleplate. If the iron stains fabric, clean the soleplate, clean the tank with a commercial cleaner, and use distilled or filtered water.
- Caution!
- Iron carefully around buttons, zippers, and other attachments or decorations that can scratch the soleplate.

### What Do I Need for Electric Iron Repair?

- Larger hardware stores may have replacement parts for popular brand electric irons. Also, you can get them from the manufacturer or an aftermarket supplier. Maintenance and repair tools you'll need to fix an electric iron include these:
- Screwdrivers
- Toothpicks or pipe cleaners

## Electrical Installation and Estimation (EE3105PE)

---

- Sewing needle
- Commercial electric iron cleaning solution or vinegar and water
- Commercial soleplate cleaner or baking soda and water
- Steel wool
- Emery cloth
- Metal cooking pot

### What Are the Steps to Electric Iron Repair?

- **Clean an electric iron:**
- Unplug the iron and make sure it is cool before cleaning.
- Use a toothpick or pipe cleaner to remove buildup in the steam vents, making sure the debris doesn't fall into the vents.
- Use a fine sewing needle to carefully clean the spray nozzle of mineral deposits.
- To flush sediment from a steam iron, pour 1/2 cup water and 1/2 cup vinegar into the water tank. Place the iron on a rack over a broiling pan and set the iron to steam until the tank runs dry. Repeat if necessary. Or follow the instructions for using a commercial iron cleaner.
- **Service an electric iron steam and spray mechanism:**
- Unplug the iron.
- Use a fine sewing needle to unclog the steam valve assembly. Also, check the valve spring and replace it if it is broken or has lost tension.
- If the spray pump is accessible, remove it and check for leaks by placing the spray tube in water and squirting the pump. Clean or replace as needed.
- **Clean an electric iron metal soleplate:**
- Unplug the iron.
- Use a sponge and commercial soleplate cleaner or baking soda and water to remove dirt buildup on the soleplate. Rinse well with water and dry. Don't use harsh abrasives or immerse an electric iron in water.
- Use very fine steel wool (0000) or an emery cloth to remove scratches and burns on the soleplate, then clean the soleplate.

### ELECTRIC FANS



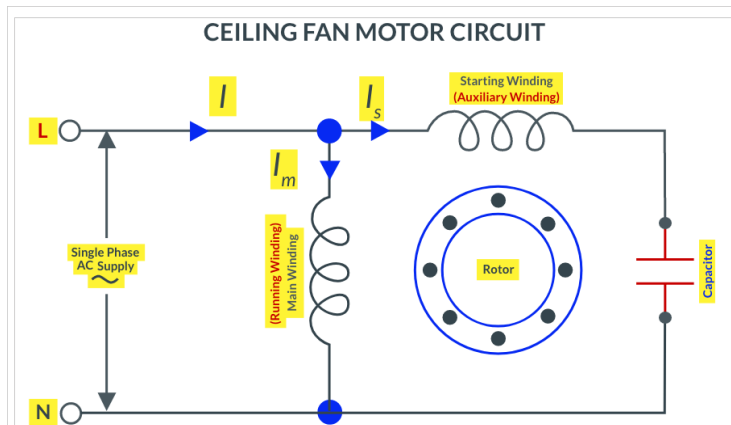
## Electrical Installation and Estimation (EE3105PE)

---

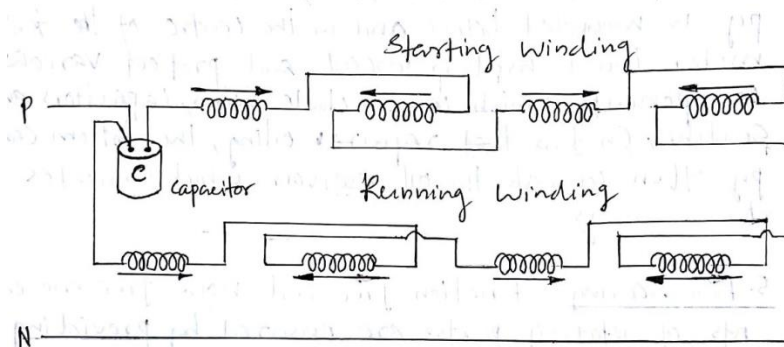
- Electric Fans are everywhere. We use them in our homes, offices, industries, factories, cars, computers, trains, etc. to circulate air and cool down the room (or an area/surface). Depending on the type of power supply, there are three types of electric fans:
- **AC Fans:** These fans run on AC mains power supply. The majority of electric fans fall under this category (including the main product of this article, the Ceiling Fan).
- **DC Fans:** These fans run on DC supply, either a regulated DC Power Supply or a battery. We use DC Fans in computers and portable fans. They are rarely used as mainstream fans nowadays as AC power supply is available everywhere and AC fans are easy to make and use.
- **AC / DC Fans:** Finally, we have the AC / DC Fans, which can run on both AC as well as DC power supplies. Hence, these fans are sometimes known as Universal Fans.
- Let us now see the different styles of electric fans that we commonly encounter in our daily lives.
- **Ceiling Fan:** It is the most popular fan that we use in our homes to circulate air and cool the room.
- **Table Fan:** You can put this fan on a table or a stool and also shift it easily from one room to other. It is a compact device where the rotor is fixed in the stator with an air gap and the base of the fan houses the capacitor and the regulator. Table Fans usually include an oscillating mechanism to oscillate the fan within certain fixed angles.
- But we are interested in the electrical aspect of the ceiling fan and here are the important electrical parts of a ceiling fan.
- We use ceiling fans in our living rooms, bedrooms, kitchens, etc. by hanging them from the ceiling. They are usually specified by the size of the blade span such as 36" (900mm), 48" (1200mm), and 52" (1300mm) being the popular options.
- **Stator:** The stator, which is the stationary part of the ceiling fan's motor, consists of two windings: Main Winding and Auxiliary Winding. A shaft or a rod pipe holds the stator.
- **Rotor:** The Rotor is the rotating part of the ceiling fan and we attach the wings/blades to the rotor. In terms of motor, the rotor is similar to a squirrel cage rotor with bars of copper or aluminum (or windings).
- **Capacitor:** As a Ceiling Fan is essentially a Single-Phase Motor, it is not self-starting. To make the motor automatic (self-starting), we use a capacitor in series with the auxiliary winding.

## Electrical Installation and Estimation (EE3105PE)

- **Regulator:** We may not want to run the ceiling fan at one speed at all times. This is where a Regulator comes in handy. We can use a regulator to regulate or set the speed of the ceiling fan. Earlier regulators are simply variable resistors in series with the ceiling fan motor. At low fan speeds, the energy is wasted by the resistor as heat and hence, energy is not saved but it is wasted.



### Coil Connection



### Repair and Maintenance

- **REQUIRED**
- Test lamp, bearing puller
- Combination pliers, Tester, Screw driver, Multi meter

### POSSIBLE FAULT AND REMEDIES

#### Fan not working

## Electrical Installation and Estimation (EE3105PE)

CAUSES	TEST	REMEDIES
1.Dry bearing. If the bearing with dry bearing ( without oil or grease) or brush friction increase heat produced and either rotate at low speed	Check grease and quality of grease after removing	By giving oil or grease this defect can be rectified
2.No supply on wall socket	Test continuity	If it is wiring fault, rewire it
3.Regulator has open circuit	Test the regulator	If it is regulator fault replace it
4.Faulty capacitor	Check the capacitor by supply or multi meter	Replace if necessary
5.Faulty regulator	Check the regulator by series test lamp	Replace if necessary
6.Open or Short circuit on field winding	Check the field winding	Rewind if necessary

- Fan works at low speed

CAUSE	TEST	REMEDY
1.Low voltage	Check the supply voltage	Give correct supply
2.Faulty capacitor	Check capacitor	Replace by new one
3..Winding fault	Check the winding	Rewind if necessary
4.Weak field winding	Check the insulation resistance of field winding	Repair it

Fan gives shock

CAUSE	TEST	REMEDY
1.Winding may be earthed end cover may be touching the open portion of winding	Test for continuity	There must be earthed by an earth wire coming from the wall socket by the third wire in the load

Fan working at low speed and become hot

## Electrical Installation and Estimation (EE3105PE)

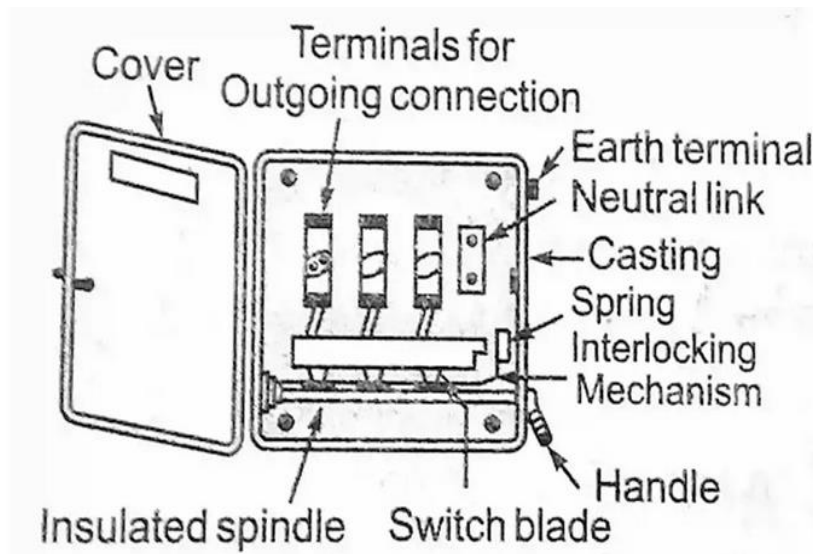
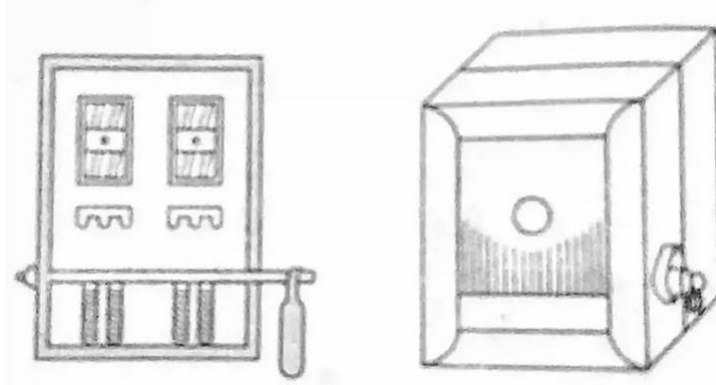
CAUSE	TEST	REMEDY
1.Capacitor is burn out	Capacitor test	Replace it
2.Blade are bended	To set the blade in correct position take them out from the grill, place the blade on the flat and clean floor in such a position so the blades may touch the floor	If bend is occur straighten by pushing or using a mallet
3.Winding shorted	Test using series test lamp	Replace winding
4.Winding earthed	Test for continuity	There must be earthed by an earth wire coming from the wall socket by the third wire in the load

### ICDP/ICTP Switch

- ICTP (Iron Clad Triple Pole) Switch  
It is used alongwith the energy meter to isolate the supply of electricity automatically or manually

### Double pole Iron-clad main switch:

- This switch shown in Fig is also referred to as D.P.I.C switch and is mainly used for single phase domestic installations, to control the main supply.
- It controls phase and neutral of the supply simultaneously.
- This switch consists of two fuse carriers.
- The one in the phase circuit is wired with the fuse and the other in neutral is linked with a brass plate or thick copper wire.
- These switches should be earthed properly to safeguard the user.
- The current rating of the switch varies from 16 amps to 200 amperes.
- Specification of these switches should have
  - current rating
  - voltage rating
  - type of enclosure (sheet steel or cast iron).



- Triple (three) pole Iron-clad main switch: This is shown in Fig and is also referred to as TPIC switch and is used in large domestic installation and also in 3-phase power circuits, the switch consists of 3 fuse carriers, one for each phase.
- Neutral connection is also possible as some switches are provided with a neutral link inside the casing. These switches need to be earthed through an earth terminal or screw provided in the outer casing
- The current rating of the switch varies from 16 to 400 amps.
- Specification of these switches should have
  - current rating
  - voltage rating
  - type of enclosure (sheet steel or cast iron)
  - whether with neutral link or otherwise
  - rewirable type fuse carriers or HRC type fuse carrier.

## Electrical Installation and Estimation (EE3105PE)

---

### Switches used in electric industry

- Switching is the most fundamental function in electronics, and plays a vital role in every system  
Most widely used switch configurations in the industry today are:
  - 1 Single Pole Single Throw (SPST)
  - 2 Single Pole Double Throw (SPDT)
  - 3 Double Pole Double Throw (DPDT)Single Pole Single Throw (SPST) is an analog switch used in many industrial instruments and consumer devices to implement test interfaces etc. It consumes very low power with maximum current in the range of 690 nA
- Normally open SPST switch can isolate multiple peripherals from source and select the required one.
- Normally closed SPST switch can connect at all times to a peripheral and when not desired the output can be totally stopped by a press of a switch.
- Some SPDT switches have a select pin and other will have a enable pin. The master in the design for digital control chooses the required trigger action
- Schmitt trigger action at select and enable control pins results in higher reliability.
- Digital bus switches are widely used multiple peripheral and host selection functions, power and clock management, sample and hold circuits, test and debug interfaces etc.

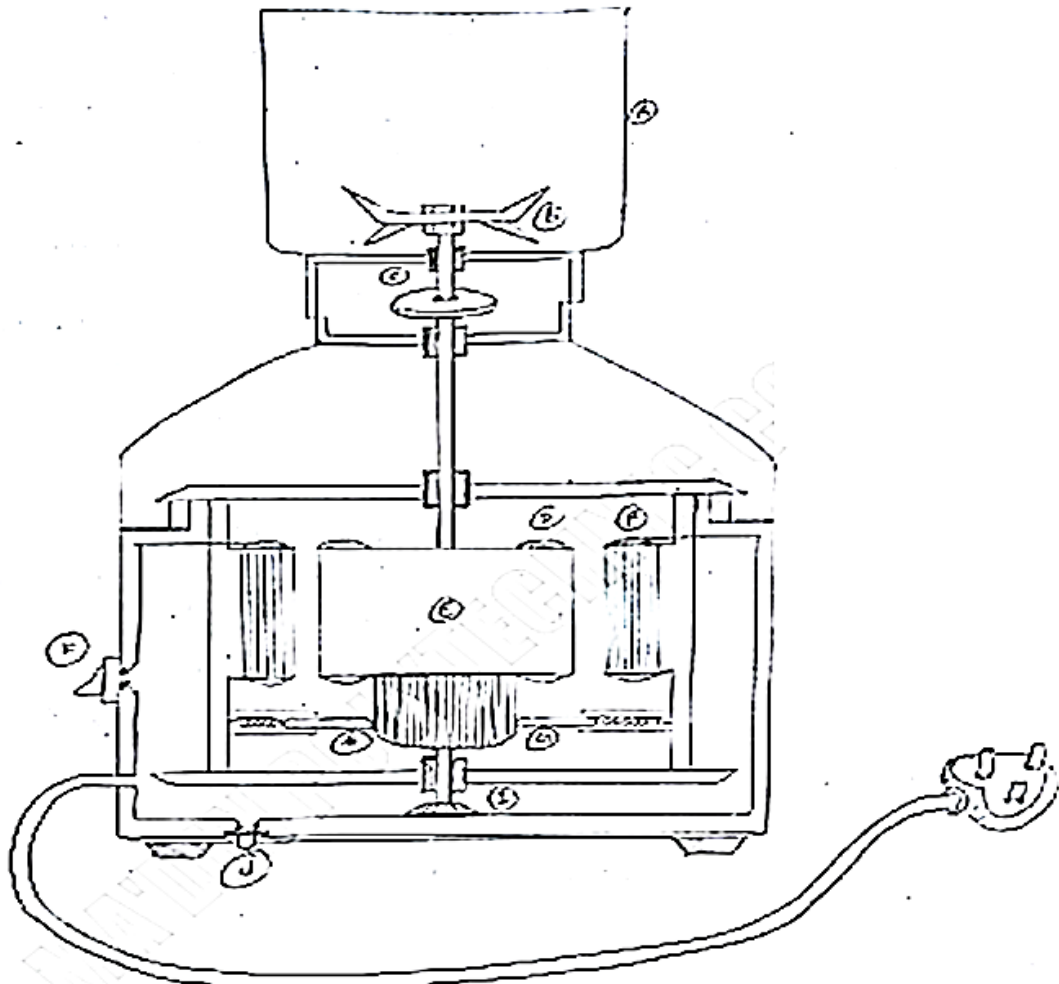
### ELECTRIC MIXER

- TOOLS REQUIRED:-
- Screw driver, Combination pliers, Test lamp, Tester, Knife
- PRINCIPLE:-
- It is worked on by using a universal motor. A universal motor may be operated either on DC or Single phase AC supply.
- Approximately same output. Being a series wound motor it has high starting torque and a variable speed characteristics. It runs dangerously high speed on no load.
- That's why such motors are would built into a device driver. I which tapings field method is usually employed for speed control purpose.



## Electrical Installation and Estimation (EE3105PE)

- In this method a field plate is tapped various points and speed is controlled by field strength for this purpose either of the following two arrangement may be used.
  - The field pole is wound in various sections with different sizes of taps are brought out from each sections.
  - Nichrome resistance is wound over one field pole and taps are brought out from te wire.
- It's very useful appliance for grinding. Another use of mixer is prepare fruit juice.
- The speed of mixer is high.
- The mixers are available in small medium and large sizes.
- Large size one is the mostly used for commercial purpose.
- The electric mixer can be divided into three parts from construction point of view.

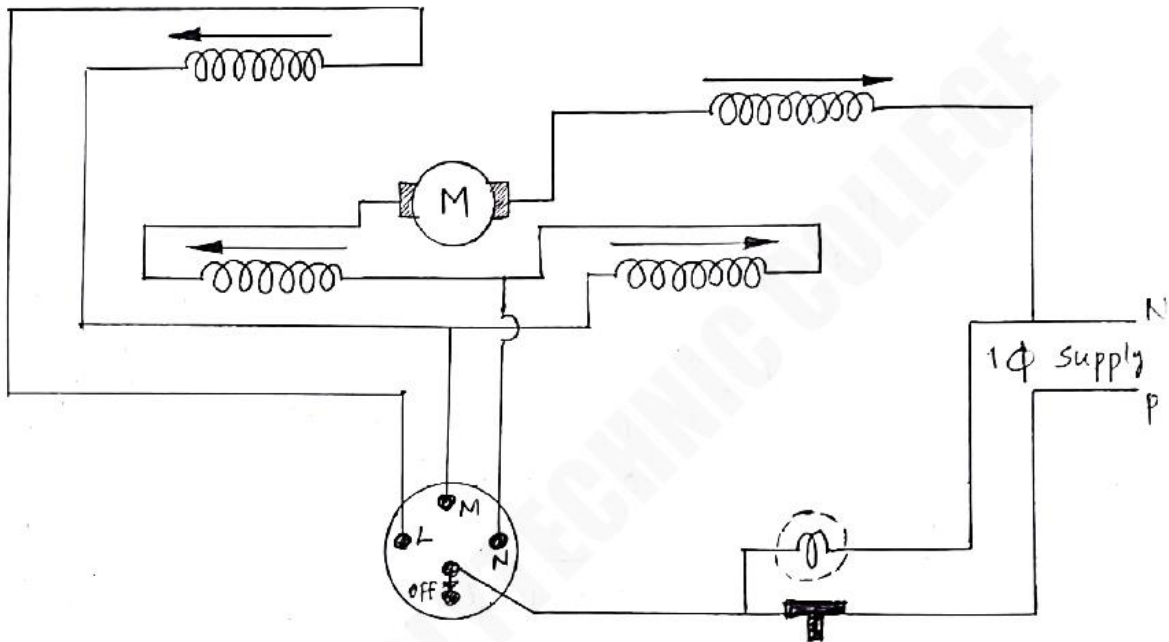


- Ⓐ JCR Ⓑ Blade Ⓒ Bush bearing Ⓓ rotor winding  
Ⓔ Rotor Ⓕ Stator winding Ⓖ Brush Ⓗ Commutator  
Ⓘ Cooling fan Ⓜ Over load protector Ⓝ switch

## Electrical Installation and Estimation (EE3105PE)

- **Base**
  - The base portion houses an electrical universal motor with a ON , OFF switch or a selected switch.
  - If it is a multi speed motor.
- **Grinder and Blender**
  - Grinder is of two types.
    - The one is for fruit juice, vegetable juice, etc... It's called blender for grinding dry and hard pieces.
    - The blades of grinder are small in size and are made of hard stainless steel.
- **Bowl**
  - The material to be grinded or mixed is put into the bowl after the preparation of it.
  - Ready the bowl along with the grinder is detached from the shaft of the motor. The content are then poured out.
  - The bowl grinding blades are coupled to the motor with the help of Dayton coupling.

### CONNECTION DIAGRAM



### POSSIBLE FAULT AND REMEDIES:-

- 1. Mixer grinder is heating

## Electrical Installation and Estimation (EE3105PE)

CAUSE	TEST	REMEDY
1. Overload	Check the load.	Reduce it.
2. Low or high supply voltage.	Check the supply voltage.	Give proper supply.
3. Bearing and couple are too tightened.	Check the tightness of bearing and couple.	If it's not normal tight it to appropriate level.

- 2. Mixer does not exist.

CAUSES	TEST	REMEDIES
1. Supply does not exist.	Check for continuity.	Replace if necessary.
2. Couple is mechanically block.	Check rotation.	Dismantle if required and test. Replace if it necessary.
3. Coil are open circuited.	Test the field coil for open circuit (test lamp).	Replace if it necessary.
4. Complaint on over load switch.	Check for switch with test lamp.	Replace if it necessary.
5. Defective the selection switch.	Check rotatory switch.	Replace if it necessary.
6. No adequate pressure on brush holder.		Replace the coil if required.
7. Short circuit on armature.	Check the armature by growler to located effective coil.	

- 3. Mixer makes sound

CAUSE	TEST	REMEDY
1. Bearing problem.	Check the bearing.	Replace it or replace if is necessary.
2. Improve coupling.	Check the joining of couples and jar.	Make it correct. Give proper supply.

## UNIT - V

### Departmental Test, REC and Electrical Act 2003

#### Introduction

- The Electricity Act, 2003, is intended to consolidate the laws relating to the Generation, transmission, distribution, trading and use of electricity and generally for taking measures to the development of electricity industry promoting competition therein protecting interest of consumers and supply of all areas, rationalization of electricity tariff, ensuring transparent policies, constitution of central Electricity Authority, Regulatory commission and establishment of Appellate Tribunal.
- In this unit, focus our attention on various departmental tests to be conducted for a wiring installation, Design of Rural Electrification Scheme and Indian Electricity Rules.

#### 1.DEPARTMENTAL PROCEDURE FOR OBTAINING A SERVICE CONNECTION

- The State Government may grant service connection on application made by the consumer in the prescribed form and on payment of the prescribed fee (if any) to supply energy in any specified area.
- There is certain procedure to obtain a service connection by a consumer. To obtain a new service connection the following steps should be followed.
- **Step-1 :**
- **Approach Customer Service Centre with Relevant Documents :**
- To get a service connection, first the consumer has to approach customer service centre to get a prescribed application form which can be had at free of cost.
- The consumer has to fill the entire particulars in the application and shall indicate his full name and address for communication.
- **Step 2:**
- **Registration of Application in the Customer Service Centre :**

## Electrical Installation and Estimation (EE3105PE)

---

- The filled-in application is then registered in customer service centre by paying Registration fee in the form of Demand Draft towards “Divisional Electrical Engineer, operation, APCPDCL”.
- The amount for D.D. depends on type of category ie. Rs. 25/- for category-I (domestic) and Rs. 50/- for other L.T. categories (commercial, industrial, agricultural etc) and Rs. 100/- for H.T. service.
- The relevant documents such as proof of ownership of the premises, wiring certificate from the licensed electrical contractor and 2 or 3 pass photo size photographs should be attached with the application.
- Then the consumer will be given an acknowledgement of the application which consists of registration number and date of registration.
- **Step-3:**
- **Line Inspector will Inspect and Examine the Premises :**
- The application from customer service centre is then sent to the concerned Assistant Engineer (A.E) operation.
- After receiving and going through the application the A.E will ask the Line Inspector to inspect the premises.
- The Line Inspector will inspect and examine the premises to fix the point of entry of service line and the position of the service cutout and energy meter in consultation with consumer and/or his licensed electrical contractor.
- After the inspection of the premises a test report with the particulars of load will be prepared and an estimate will be formulated.
- **Step-4 :**
- **Submission of Test Report and Estimation to Assistant Engineer (A.E)/Assistant Divisional Engineer (A.D.E) :**
- The Line Inspector will submit the test report and estimation in a prescribed form to A.E/A.D.E. After studying the report the A.E/A.D.E will ask the section officer to intimate the consumer in the prescribed proforma to pay the deposits and keep ready the service wire etc.
- **Step-5 :**
- **Payment of Service Connection Charges and Security Deposit :** Now the consumer has to pay
- (a) Service Line charges (for extension work),

## Electrical Installation and Estimation (EE3105PE)

---

- (b) Development charges and
  - (c) Security deposit in the form of Demand Draft towards “Divisional Electrical Engineer, operation, APCPDCL”.
  - The amount of charges depends on number of kW (for domestic) or H.P (for industrial and agricultural). The security deposit will be taken normally for 3 months consumption charges. All the charges and deposits shall be in the form of crossed demand draft and will not accepted in cash. The section officer will issue temporary receipt for all the deposits obtained.
  - **Step-6 :**
  - **Allotment of Service Number and Energy Meter :**
  - After payment of deposits, the service number and energy meter will be allotted with in one month on seniority basis. Then the A.E. of the sub-division will issue the work order for the metering equipment.
  - **Step-7 :**
  - **Fixing of Energy Meter :**
  - The service line and the metering equipment will be laid and erected in the consumer premises.
  - The service line will be connected to the mains and service will be released.
  - After this, a test report will be collected in the prescribed proforma and sent to Electricity Revenue Office (ERO) for billing.
  - The supplier (State Electricity Board) may affix one or two seals to any cut-out and energy meter and no person other than the supplier shall break a such seal.
  - The electricity bill should be paid at the bill collection centre monthly/bi-monthly as per the norms of the Electricity Board Tariff.
  - **Note:**
  - The same service procedure is to be adopted to get the service connection for Industries (H.T) and Agricultural loads. In such cases :required to enable the department to make longer notice which may extend to six months necessary arrangements.
3. INSULATION RESISTANCE DESIRABLE FOR ELECTRICAL INSTALLATION  
Before energising any installation system the installation should be inspected and tested to make sure that there is no short circuit fault, earth leakage, discontinuity etc. and the wiring job has been carried out in accordance with requirements of Indian Electricity Rules.



## Electrical Installation and Estimation (EE3105PE)

The chances for breaking of conductor section are :

1. Scrapping of insulation while drawing, laying,
2. Puncturing of insulation while fixing clips,
3. Driving nails, screws etc.

These are unavoidable and these necessitate the testing of installation work before connecting it with the supply mains i.e. energising it.

- Megger is a portable instrument which is generally used for testing of installation.
- It is a combined unit of an ohm-meter and D.C. hand driven Generator.
- **1. Insulation Resistance of an Installation :**
- The insulation resistance shall be measured by applying a D.C. voltage not exceeding 500V for medium voltage circuits between the earth and the whole system of the conductor.
- The insulation resistance in mega-ohms of an installation shall not be less than
- The insulation resistance in any case should not be less than 0.5 MQ and need not be more than 1 Mega ohm,
- In case of P-V.C cables insulation resistance is equal to

12.5MΩ

No. of points in the circuit

### 2. Insulation Resistance of Motors and Other Equipments :

The insulation resistance of each phase winding against the frame and between the windings shall be measured.

A Mega ohm-meter of 500 V (or) 1000 V rating shall be used.

Minimum acceptable value of insulation resistance in MQ at 25°C

Where E = Rated phase to phase voltage in volts.

P = Rated power in kW.

### 3. EARTH RESISTANCE TO BE MAINTAINED FOR AN ELECTRIC INSTALLATION

- The main purpose of Electrical installation (equipment) earthing is to safe guard human being from shock hazards.

## Electrical Installation and Estimation (EE3105PE)

- In order to achieve effective operation, the earth electrode resistance should be lower than an acceptable value which could be calculated from circuit details.
- This low resistance will discharge the leakage current to earth and safe guard the human being from risk of electric shock.

$$\text{The value of earth resistance in ohms} = \frac{\text{Voltage}}{\text{Leakage current}} = \frac{V}{I}$$

- The maximum permissible values of earth resistances below for various electrical installations
- 1. Large Power Stations = 0.5 Q
- 2. Major Sub-Stations = 1.00
- 3. Small Sub-stations = 200
- 4. In all other cases = 5.090

### 4.NECESSITY OF INSPECTION AND TESTING OF WIRING INSTALLATION

- On completion of the wiring, a general inspection shall be carried out by competent personnel in order to ensure that there is no short circuit, earth leakage or discontinuity etc. moreover the wiring is done according to the Indian Electricity Rules.
- The main objective of this inspection is to check whether all equipment, fittings, accessories, wires/cables used in the installation are of adequate rating and quality to meet the requirements of the load.
- Also the layout, finish, neatness, clearances, tightness of termination, rating of protective devices and their settings must also be inspected and checked.
- After inspection, various tests shall be carried out before an installation or an addition to the existing installation is put into service.
- Any testing of the electrical installation shall commence after obtaining permit to work from the engineer in-charge and after ensuring the safety provisions.
- The instrument used for this testing is the 'Megger'.
- An authorized contractor will state and certify that the wiring has been done according to the Indian Electricity Rules and leakage current will not exceed 1/5000" of the total current between two conductors of opposite polarity or between any live conductor and the earth.
- The leakage current can be determined by the following formula.

## Electrical Installation and Estimation (EE3105PE)

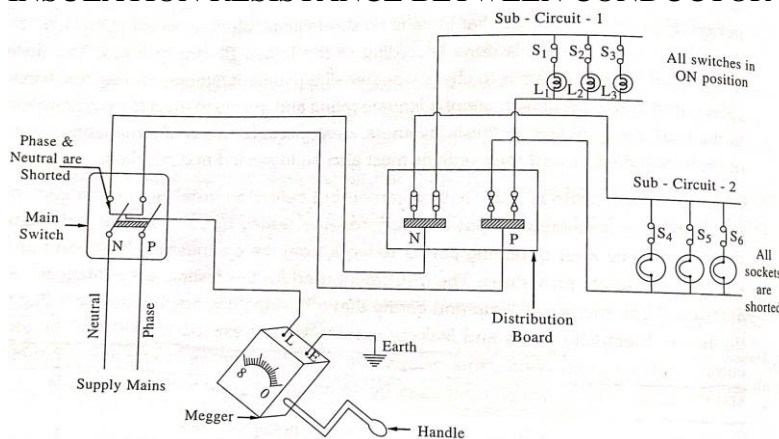
- Leakage current in Amps =

Supply voltage in volts/(Insulation Resistance in mega Ohms)

### 5. TESTING OF WIRING INSTALLATION

- Before energizing any new installation system or an addition to an existing system following tests shall be carried out to ensure that the wiring installation is satisfactory in all respects.
- 1. Insulation resistance between conductor and earth.
- 2. Insulation resistance between the conductors.
- 3. Polarity of single-pole switch.
- 4. Wiring continuity or open circuit
- 5. Earth continuity test.

#### 1. INSULATION RESISTANCE BETWEEN CONDUCTOR AND EARTH



- The objective of this test is to find the insulation resistance between the conductors of opposite polarity (phase and neutral).
- The following steps should be followed for this test.
- (i) Put the main switch in OFF Position and remove the fuse carriers.
- (ii) Keep all the distribution board fuses in position
- (iii) Insert all the lamps in their holders and all Switches for fans & lights should be "ON position.
- (iv) Put load in the sockets and keep the Switches in ON position
- (v) Short-circuit phase and neutral terminals on the installation side
- (vi) Connect the Line (L) terminal of the megger phase wire and earth terminal of the megger to neutral in main switch as shown in Fig.
- (vii) Rotate the handle of the megger at its ratcircuit formed between conductors and earth.
- (viii) Note down the reading of the megger shown by its needle deflection.
- The reading of the megger Gives directly the insulation resistance between the conductor and earth in mega-ohms.

## Electrical Installation and Estimation (EE3105PE)

---

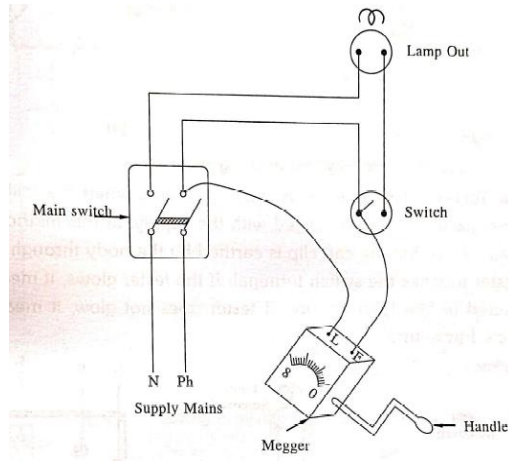
- According to I.E. rules, the measured insulation resistance should not be less than 50 mega-ohms divided by number of outlets (points + switches).
- The measured insulation resistance of the installation in any case should not be less than 0.5 M-ohm and need not be more than 1 M-ohm.

### 2 INSULATION RESISTANCE BETWEEN CONDUCTOR

- The object of this test is to find the insulation resistance between the conductors of opposite polarity (phase and neutral).
- Procedure :
- The following steps should be followed for this test.
- 1. Put main switch in OFF position and remove the fuse carriers.
- 2. Distribution board fuses should be in position.
- 3. Remove all lamps from their holders and all the switches for lights & fans should be in ON position.
- 4. Disconnect the load in the sockets and keep the switch in ON position.
- 5. Connect the Line (L) terminal of the megger to phase wire and Earth (E) terminal of the megger to neutral in the main switch as shown in Fig.
- 6. Rotate the handle of the megger at its rated speed to send current through the circuit.
- 7. Note down the reading of the megger shown by the needle deflection.
- The reading of the megger gives directly the insulation resistance between the conductors in mega-ohms.
- According to I.E. rules, the measured insulation resistance should not be less than 50 mega-ohms divided by number of outlets (points + switches).
- The measured insulation resistance of the installation in any case should not be less than 0.5 MQ and need not be more than 1 MQ.

### 3. POLARITY OF SINGLE POLE SWITCH

- This test is conducted to check whether the switches are connected in phase (live) wire or not.
- According to I.E. rules the switches should be connected in live wire. The polarity test can be carried out in three ways i.e. by using,
  1. Megger
  2. Test lamp and
  3. Neon Tester.
- By using Megger :
- The following steps should be followed for this method.
- (a) All the lamps are removed from their h
- (b) The fan regulators are kept in OFF position.
- (c) Keep all the fuses in Position
- (d) Remove the covers of all switches, (e) Connect Line (L) terminal of the megger to ph(E) terminal to the individual switch terminal phase wire in the main switch and Earths turn by turn as shown in Fig.

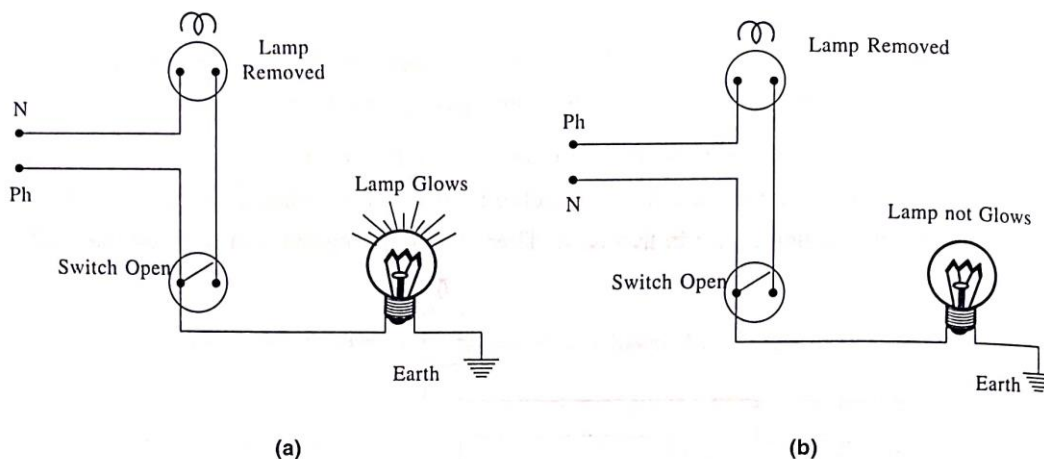


### 2. By using Test Lamp

This system is possible when the installation is already energized i.e., it is connected with the supply. It is very common appliance and is kept by all wire-men and electricians for quick testing. The following steps should be followed for this method.

- (a) Remove all the lamps from their holders and keep all the switches in OFF position.
- (b) Insert main fuse and put the main switch in ON position.
- (c) Connect one end of the test lamp to earth and another end to switch contact in turn as shown in Fig.

Now, if the test lamp glows on one of the two contacts of the switch, it indicates that the switch is connected in phase (live) wire, if test lamp does not glow, it indicates that the switch is connected in neutral.



### 3. By using Neon Tester

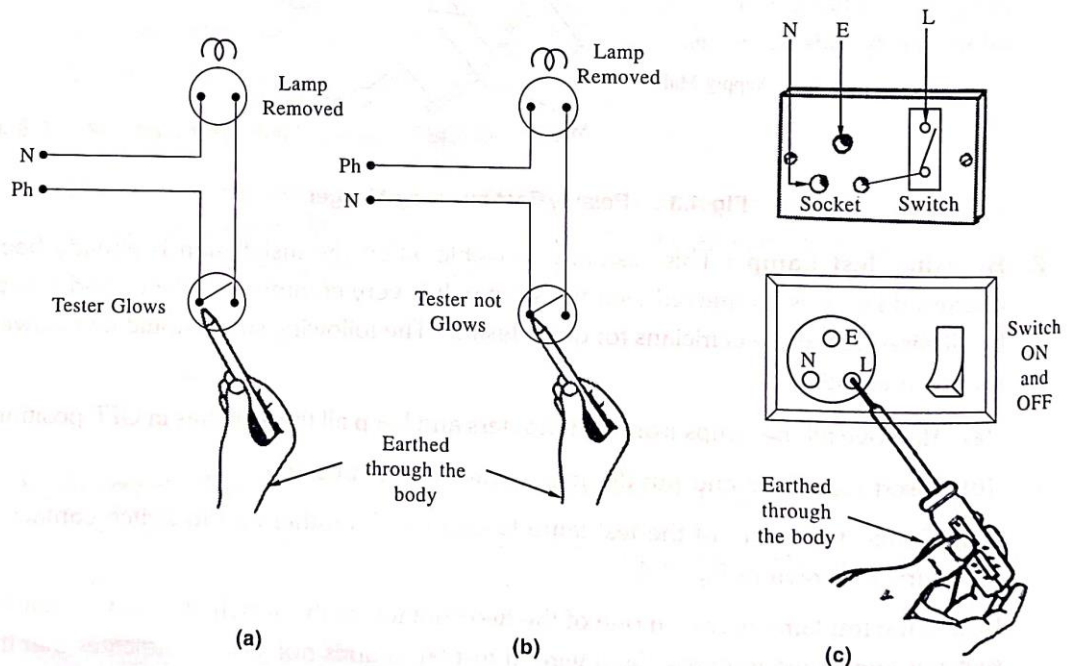
This method is only applicable when the installation has been already energized i.e. it is connected with the supply.

In this method the tester is held in the hand such that the cap clip is earthed by the body through hand when the tip of the tester touches the switch terminal.

## Electrical Installation and Estimation (EE3105PE)

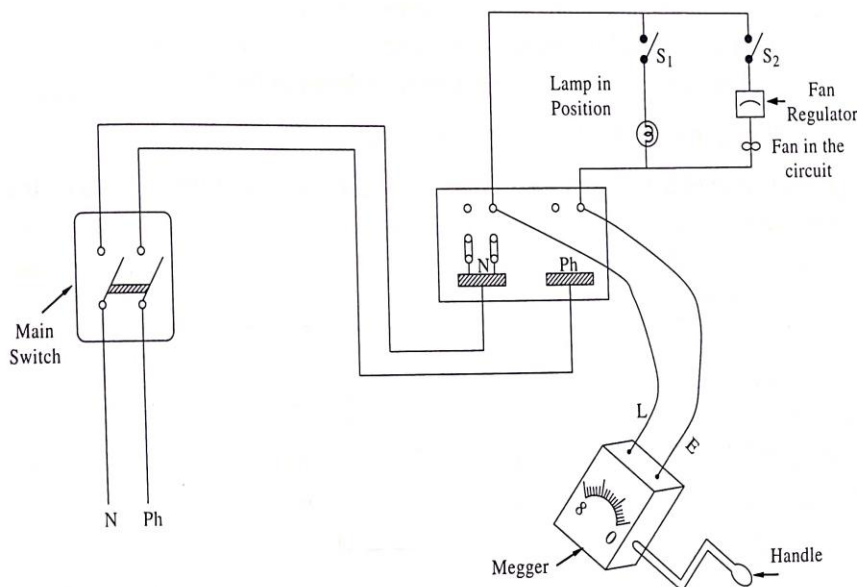
If the tester glows, it means that the switch is connected in live (phase) wire, if tester does not glow, it means that the switch is connected in neutral.

Test can also be done on the socket to verify whether, the phase wire is connected to the right side hole of the socket or not as shown in Fig. 4.5 (c). and the switch controls the phase



### 4 WIRING CONTINUITY OR OPEN CIRCUIT TEST

- This test is carried out for checking the continuity of the circuit, sub-circuit and load points.



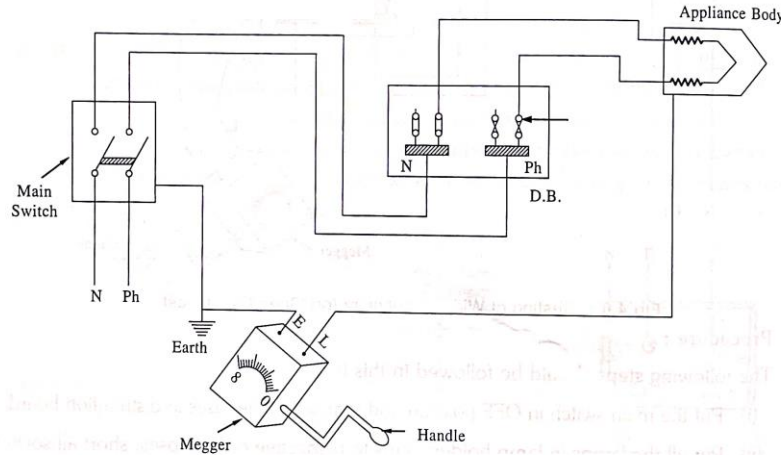
- Procedure :
- The following steps should be followed in this test.
- (i) Put the main switch in OFF position and remove all the fuses in distribution board.
- (ii) Put all the outlets.
- (iii) Keep all the switches in OFF position.



## Electrical Installation and Estimation (EE3105PE)

- (iv) Connect the megger terminals L and E to the individual circuit phases and neutral lamps in lamp holders, fans to respective ceiling roses, short all socket as shown in Fig.
- (v) Rotate the Megger handle and put the switches ON and

### 5 EARTH CONTINUITY TEST



- This test is carried out to check the earth continuity of the installation.
- Procedure :The following steps should be followed in this test.
- (i) Put main switch in OFF position and take out the main fuse.
- (ii) Kept all lamps in their lamp holders and kept all the switches in ON Position,
- (iii) Connect Earth (E) terminal of the megger to earth wire at the main switch and Line (L) terminal should be connected to all the metallic parts of the installations and earth terminal of the 3-pin socket as shown in Fig.
- (iv) Rotate the handle of the Megger at its rated speed.
- If the needle of the megger shows zero reading, it means that the circuit is earthed or grounded.
- If megger shows infinity, it means that there is a break in the earth wire, hence check and remove the fault.

### 6 RURAL ELECTRIFICATION SCHEME

- The Scheme through which Rural Electrification is carried out is known as Rural Electrification Scheme.
- This scheme is organized by Rural Electrification Corporation(R.E.C), whose head office is at Delhi.
- The main functions of Rural Electrification Corporation are:
  - (i) Achieving of 100% Electrification of the Colonies, Habitations, Harijanwadadas etc.
  - (ii) Erection of new sub-stations providing of additional Transformers for reduction of low voltage and providing of intermediate poles to improve the distribution network and to reduce the line losses.
  - (iii) Energisation of Agricultural Pump-sets, replacement of meters with high accuracy meters and Providing of Air-Blast (A.B) cables in the theft prone areas to reduce the theft.

## Electrical Installation and Estimation (EE3105PE)

---

- For achieving all targets, the R.E.C is mobilizing funds from various government bodies and from the abroad also.
- The R.E.C may provide 100% or some percentage of subsidies for Rural electrification depending on the type and place of erection work.
- These schemes are generally executed 1 year to 3 or 4 year depending on the work.

### 7.SURVEY OF LOAD PARTICULARS IN A VILLAGE

- Before taking up of the erection of lines both L.T & H.T. in a village, it becomes necessary to survey the load particulars.
- The survey of the load should be carried out accurately.
- In general the various types of loads in a village are as follows.
- (i) Domestic load
- (ii) Industrial load
- (iii) Agricultural load
- (vi) Commercial load
- (v) Street lighting load
- (vi) Temples, Hospitals, Hotels etc.
- Having marked the position of the load on the map, on the basis of the walk over survey, a detailed load survey can be carried out for effective electrification of a village.
- After load survey, a detailed route survey for the lines has to be made and alignment of the lines should be done.
- The proposed route shall be of the shortest practicable distance.
- The first thing to do is, select the route and plot it on a map. The second step is to conduct a walk survey to determine the topography of the area and any obstacles likely to come across.
- The following area should be avoided as far as possible.
- (i) Abrupt changes in the line route.
- (ii) Restricted access for transport vehicles.
- (iii) Difficult crossings.
- (iv) Private land.

## Electrical Installation and Estimation (EE3105PE)

---

- (v) Railway track crossing.
- (vi) Telephone line crossing.
- (vii) Crossing over buildings.
- (viii) River/pondage crossings.
- For the river on which the crossing is to be done, the dates of high flood level of atleast the previous 20 years is to be obtained from the revenue authorities and clearance is to be designed.
- The Railway and Road crossings should be as minimum as possible.
- Proper guarding is necessary at the road, Railway line, Communication line crossings.
- For conducting a survey of distribution lines in a village, a scaled map of the Village taken and following are marked on the map.
  - 1. The nearest H.T. lines from which the tapping will be taken for the distribution transformer.
  - 2. The location of distribution transformer after taking into consideration the distribution of load.
  - 3. The layout of the L.T. lines network with location of angle poles and road crossings.

### 8.CAPACITY OF TRANSFORMER

- The Transformer located in rural areas is called Distribution Transformer(11 kV/440 V).
- The capacity (rating) of the transformer depends on the total load, Studies have revealed that, the capacity of distribution transformer should much greater than the total load.
- For an existing distribution system the appropriate Capacity of transformer may be taken by considering a suitable Diversity Factor to meet the future increased load demand.
- Generally a diversity factor of 1.5 may be assumed for distribution transformer.
- For example if the total load is 500 kVA, the transformer capacity is  $500 \times 1.5 = 750$  kVA.

### 1.DETERMINATION OF CAPACITY OF A TRANSFORMER

- PROBLEM --1:

## **Electrical Installation and Estimation (EE3105PE)**

---

- Determine the capacity of a transformer required in a village for the following load particulars.
- a) 100 No's of domestic loads of 500W each.
- b) 2 Industries with 5 H.P. motors each,
- c) 50 Agricultural pump-sets with 2 H.P. motors each.

1 Hospital with a load of 10 kW load

- Assuming the efficiency and power factor of Industrial motors and Agricultural pump-sets as 85 % and 0.8 p.f. lag. respectively.
- For domestic and hospital load efficiency as 100 % and p.f being unity.

$$1. \text{ Domestic load} = \frac{100 \times 500}{1 \times 1 \times 1000} = 50 \text{ kVA}$$

$$2. \text{ Industrial load} = \frac{2 \times 5 \times 735.5}{0.85 \times 0.8 \times 1000} = 10.816 \text{ kVA}$$

$$3. \text{ Agricultural load} = \frac{50 \times 2 \times 735.5}{0.85 \times 0.8 \times 1000} = 108.161 \text{ kVA}$$

$$4. \text{ Hospital load} = \frac{1 \times 10}{1} = 10 \text{ kVA}$$

$$\text{Total} = 178.977 \text{ kVA}$$

- Capacity of a Transformer
- = Total load x diversity factor
- =  $178.977 \times 1.5 = 268.465 \text{ kVA}$
- The choice of capacity of Transformer is as follows.
- 1. One Transformer of a capacity of 300 kVA (because 268.465 kVA rating transformer is not available).
- 2. One transformer of capacity 200 kVA for supplying agricultural load and another of rating 100 kVA for supplying Domestic, Industrial and Hospital load.

### 9.LOCATION OF TRANSFORMER

- The distribution transformer is generally placed on H-type poles (called pole-mounted transformer) or on a plinth (called plinth-mounted transformer).

## Electrical Installation and Estimation (EE3105PE)

---

- The transformer should be located at the load centre to keep the voltage drop and losses within permissible limits.
- If the transformer is not located at the load centre, then the farthest consumer obtain an extremely low voltage even though a reasonably good voltage level is maintained at the transformer secondary.
- If a village has limited load including agricultural load, then one transformer is sufficient.
- If a village has more agricultural load, then it is advisable to install two transformers, one for supplying agricultural loads and another for supplying other loads (domestic, industrial, commercial etc.).

### 9.1 VOLTAGE REGULATION

- Owing to the variations in the current flow through a transmission and distribution line, there is variation in the voltage drop in the line. Thus the receiving end voltage changes with changing load.
- It is necessary under electricity rules to maintain the voltage at the receiving end of lines within permissible limits as given below.
  1. Voltage upto 33 kV =  $\pm 6\%$
  2. Voltage above 33 kV =  $\pm 12.5\%$
- The voltage regulation is usually considered as the percentage drop with reference to the receiving end voltage.
- Percentage regulation =  $\frac{E_s - E_r}{E_r} * 100$
- Where  $E_s$  = Sending end voltage and
- $E_r$  = Receiving end voltage.
- The voltage regulation of the line depends on type of conductor, kW-km, voltage drop and power factor.
- The kW-km for 11 kV, 3 lines for 1% voltage drop constants at various power factors are given in Table.
- The Regulation factors for different conductors is as follows.
- The above values are for a conductor temperature of 60°C.
- For a conductor temperature of 50°C the above values shall be about 3 % higher and for a temperature of 70°C about 3 % lower.

## Electrical Installation and Estimation (EE3105PE)

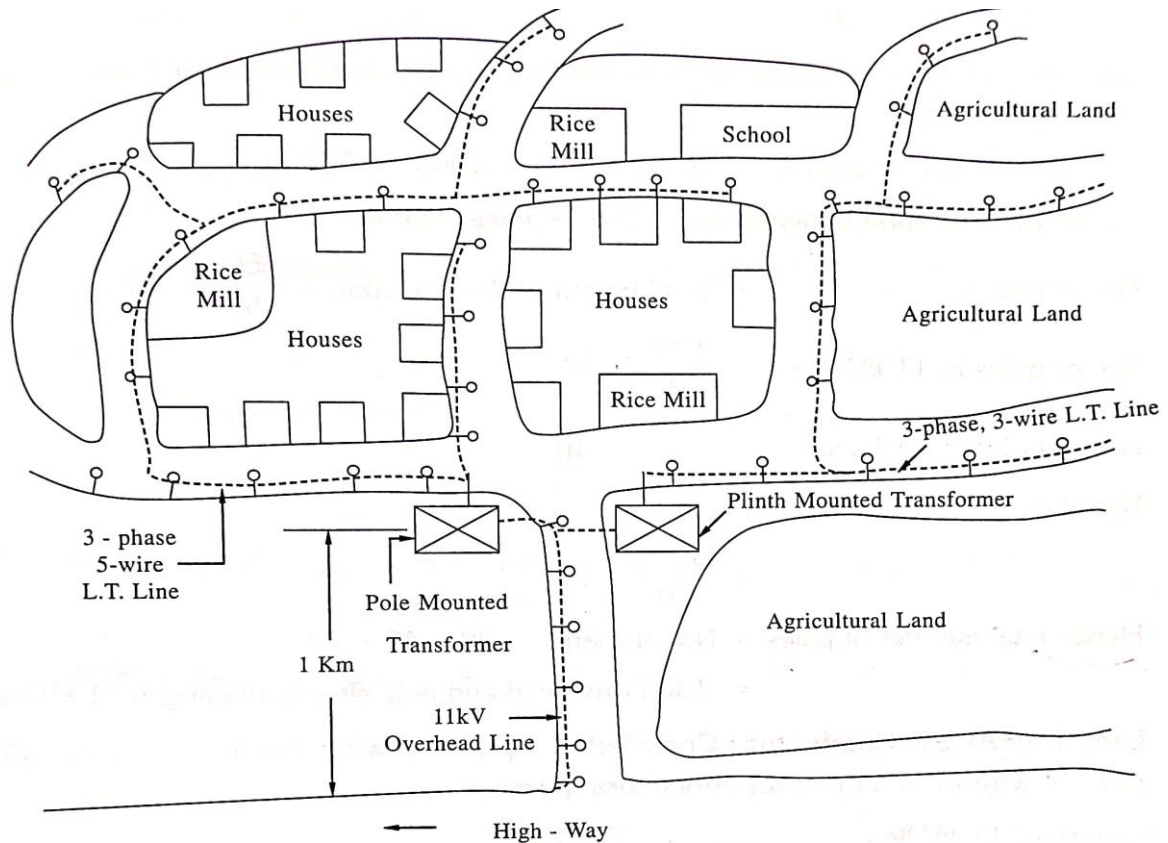
- 11 kV % regulation =  $\frac{kW - km}{Diversity\ Factor\ (D.F) \times Regulation\ constant}$
- =  $\frac{kVA - km \times Power\ factor}{Diversity\ Factor\ (D.F) \times Regulation\ constant}$
- L.T % regulation =  $\frac{kW - km}{Diversity\ Factor\ (D.F) \times Regulation\ constant}$
- =  $\frac{kVA - mts \times 0.0007355}{Diversity\ Factor\ (D.F) \times Regulation\ constant}$

### PROBLEM:-.1

- Prepare an estimate for the quantity of materials required and their cost for a village electrification which has loads of
- (a) 162 No's domestic loads each 500 W.
- (b) 3 No's rice mills each of 10 H.P.
- (c) Street lights of 23 No's each of 40 W.
- (d) 23 No's agricultural load each of 7.5 H.P.
- Assume any missing data.
- Assumptions :
- A 3-phase, 5-wire system is running in the village for supplying domestic, rice mills, street lights for a length of 2km.
- A 3-phase, 3-wire system is required for supplying agricultural pump sets for length of 3.5 km.
- The efficiency and power factor of motors is 85 % and 0.8 lagging. respectively.
- Diversity Factor of the loads is 1.5.
- Average span = 50 m



## Electrical Installation and Estimation (EE3105PE)



- 1. Capacity of Transformer :

$$\begin{aligned}
 \text{(i) Domestic load} &= \frac{162 \times 500}{1000} = 81 \text{ kVA} \\
 \text{(ii) Rice mill load} &= \frac{3 \times 10 \times 735.5}{0.85 \times 0.8 \times 1000} = 32.448 \text{ kVA} \\
 \text{(iii) Street light load} &= \frac{23 \times 40}{1000} = 0.92 \text{ kVA} \\
 \text{(iv) Agricultural load} &= \frac{23 \times 7.5 \times 735.5}{0.85 \times 0.8 \times 1000} = 186.579 \text{ kVA} \\
 \text{Total} &= 300.947 \text{ kVA}
 \end{aligned}$$

Taking diversity factor 1.5 into consideration,

The capacity of transformer to be installed =  $300.947 \times 1.5 = 451.42 \text{ kVA} = 500 \text{ kVA}$ .

It is proposed to install two transformers of rating 300 kVA and 200 kVA.

(The transformers of capacity above 250 kVA- Plinth Mounted Sub-station)

The 300 kVA transformer (plinth mounted) is exclusively for Agricultural load and 200 kVA transformer (pole mounted) is for other loads (domestic, rice mills, street lights etc.)

- 2. No. of Poles required :

## **Electrical Installation and Estimation (EE3105PE)**

---

- The input to the distribution transformer is to be fed from 11 kV line which is at a distance of 1 km.
- Total length of the line =  $(2+3.5+1) \times 1000 = 6500$  m
- Let an average span between two adjacent poles = 50m
- No. of spans = Total length of the line/span =  $6500/50 = 130$
- No. of poles in 11 kV line =  $1000/50 = 20$
- No. of poles in a village =  $2000/50 = 40$
- No. of poles for agricultural purpose =  $3500/50 = 70$
- Hence total number of poles = No. of spans
- =  $20 + 40 + 70 = 130$  ( one dead end pole already existing in 11 kV line).
- **3. Length of ACSR Conductor :**
- Considering 3-phase, 5-wire system in a village and 3-phase, 3-wire (415 V) line for agricultural purpose.
- Length of 11 kV line = 1000 m
- Length of 3-phase, 5-wire line = 2000m
- Length of 3-phase, 3-wire line = 3500 m
- Total length of ACSR conductor (7/2.59 m) for 11 kV line =  $3 \times 1000 = 3000$  m
- Total length of ACSR conductor (7/2.11 m) for L.T. line =  $5 \times 2000 + 3 \times 3500 = 20500$  m
- **4. No. of Insulators :**
- Considering 5 (five) 90° angle points with in a village and 6 (six) angle points and 1 dead end pole in agricultural line.
- No. of 11kV pin insulators =  $20 \times 3 = 60$
- No. of 11 kV Disc insulators =  $1 \times 3 = 3$
- No. of L.T. pin insulators =  $(3 \times 63 + 4 \times 35) = 189 + 140 = 329$
- No. of L.T Reel insulators =  $40 \times 1 = 40$
- No. of L.T shackle insulators =  $(5 \times 4 + 7 \times 3) \times 2 = (20 + 21) \times 2 = 82$

### **ECONOMIC FEASIBILITY OF THE SCHEME**

## Electrical Installation and Estimation (EE3105PE)

---

- Its on which required for completion of the scheme most economically, which may consists of the following
- 1. Economical load centre.
- 2, Economical length of the transmission and distribution line
- 3. Economical of the cost of the land
- 4. Economical for easy transportation of the main and auxiliary equipment

### INDIAN ELECTRICITY (I.E) RULES

- These rules extract are from the Indian electricity rules.
- Before actually studying Indian Electricity rules (I.E. Rules) and other precautions, we should realise why these rules and regulations have been framed.
- The rules and regulations have been framed by competent authority to:
  - 1. Safe guard consumers of electrical energy from shock.
  - 2. Minimize risk of fire.
  - 3. Ensure satisfactory operation of equipment and apparatus used.
- **Rule-1 : Short Title and Commencement :**
- (i) These rules may be called the Indian Electricity Rules, 1956.
- (ii) They shall come into force at once.
- **Rule-2 : Definitions**
- In these rules, unless the context otherwise requires
- (a) “The Act” means means the Indian Electricity Act, 1910;
- (b) “Accessible” means within physical reach without the use of any appliance or special effort;
- (c) “Ampere” means a unit of electric current and is the unvarying electric current which when passed thorough a solution nitrate of silver in water, in accordance with the specification set out in Annexure 1 , deposits silver at the rate of 0.001118 of a gramme per second.
- (d) “Annexure” means an annexure to these rules;
- (e) “Apparatus” means electric apparatus and all machines, fittings, accessories and appliance in which conductors are used;
- (f) “Authorised person” means a Person

## Electrical Installation and Estimation (EE3105PE)

---

- (g) “Bare” means not covered with insulating material;
- (h) “Cable” means a length of insulated single conductor (solid or stranded) Or two or more such conductors, each provided with its own insulation, which are laid up together. Such insulated conductors may or may not be Provides with an overall mechanical protective covering;
- (i) “Flexible cable” means a cable consisting of one or more cores each formed of a group of wires, the diameter and the physical properties of the wires and the insulating material being such to afford flexibility;
- (j). “Circuit” means an arrangement of conductor or conductors for the Purpose of conveying energy and forming a system or a branch of a system:
- (k) “Circuit breaker” means a device, capable of making and breaking the circuit under all conditions and unless otherwise specified, so designed as to break the current automatically under abnormal condition;
- (l) “Concentric” means a composite cable comprising an inner conductor which is insulated and one or more outer conductors which are insulated from one another and are disposed over the insulation of and more or less around the inner conductor:
- (m) “Conductor” means any wire, cable, bar, tube, rail or plate used for conducting energy and so arranged as to be electrically connected to a system;
- (n) “Conduit” means rigid or flexible metallic tubing or mechanically strongand fire-resisting non-metallic tubing into which a cable or cables may bedrawn for the purpose of affording it or them mechanical protection;
- (o) “Covered with insulating material” means adequately covered with insulating material of such quality and thickness as to prevent danger;
- (p) “Cut-out” means any appliance for automatically interrupting the transmission of energy through any conductor when the current rises above predetermined amount and shall also include fusible cut-out;
- “Danger” means danger to health or danger to life or any part of body from shock, burn or other injury to persons or Property or from fire or explosion.
- “low” where the voltage does not exceed 250 volts under normal conditions subject, however, to the percentage variation allowed by these rules;
- “medium” where the voltages does not exceed 650 volts under normal conditions subject, however, to the percentage variation allowed by these rules:
- ”high” where the voltage do: s not exceed 33,000 volts under normal conditions subject, however, to the percentage variation allowed by these rules;

## Electrical Installation and Estimation (EE3105PE)

---

- “extra high” where the voltage exceeds 33,000 volts under normal conditions subject, however, to the percentage variation allowed by these rules;
- (v) “electrician” means a person over 21 years of age, who is competent for the purpose of the rule in which the terms is used and who has been appointed in wiring by the owner, agent or manager of installation.
- **Rule-3 :** Authorization owner, agent or manager of a mine, or the agent of analyzed well in an oil-field or a contractor to carry out duties incidental
- A supplier or a consumer, of the oil-field or the owner of a drilled well in an for the time being a under contract with the generation, transformation, transmission, Conversion and distribution.
- **Rule-4 : Qualification of Inspectors**
- No person shall be appointed to be an Inspector unless-
- i) He possesses a degree in electrical engineering or its equivalent university or institution; and
- (ii) he has been regularly engaged or less than two years have

### GENERAL SAFETY PRECAUTIONS :

- **Rule-29 : Construction, Installation, Protection, Operation and Maintenance of Electric Supply Lines and Apparatus :**
- All electric supply line and apparatus shall be of sufficient ratings for power, insulation and estimated fault current and of sufficient mechanical strength, or the duty which they may be required to perform under the environmental conditions of installation and shall be constructed, installed, protected, worked and maintained in such a manner as to ensure safety of human being, animals and property.
- **Rule-30 : Service Lines and Apparatus on Consumer’s Premises :**
- (i) The supplier shall ensure that all electric supply lines, wires fittings and apparatus belonging to him or under his control, which are on a consumer’s premises are in safe conditions and in all respects fit for supplying energy and the supplier shall take due precautions to avoid danger arising on such premises from such supply lines, wires fittings and apparatus.
- (ii) Service lines placed by the supplier on the premises of a consumer which are under ground or which are accessible shall be so insulated and protected by the supplier as to be secured under all ordinary conditions against electrical, mechanical, chemical or other injury to the insulation.
- (iii) The consumer shall, as far as circumstances permit, take precautions for the safe custody of the equipment on his premises belonging to the supplier.

## **Electrical Installation and Estimation (EE3105PE)**

---

- (iv) The consumer shall also ensure that the installation under his control maintained in a safe conditions.

### **Rule-31 : Cut-out on Consumer's Premises :**

- (i), 'The supplier shall provide a suitable cut-out in each conductor of every service line other than earthed or earthed neutral conductor or the earthed) conductor of a concentric cable with in a consumer's premises, in position. Such cut-out shall be contained within an adequately enclosed fireproof receptacle.
- Where more than one consumer is supplied through a common service line, each such consumer shall be provided with an independent cut-out at the point of junction to the common service.
- (ii) Every electricity supply line other than the earthed or earthed neutral conductor of any system or the earthed external conductor of a concentric cable shall be protected by a suitable cut-out by its owner.

### **Rule-32 : Identification of Earthed Neutral Conductor and Position of Switches and Cut-out Therein :**

- Where the conductors include an earthed conductor of a two-wire system or an earthed neutral conductor of a multi-wire system or a conductor which is to be connected there to, the following conditions shall be complied with.
- (i) An indication of a permanent nature shall be provided by the owner of the earthed or earthed neutral conductor, or the conductor which is to be connected there to, to enable such conductor to be distinguished from any live conductor.
- Such indication shall be provided :
  - (a) Where the earthed or earthed neutral conductor is the property of the supplier, at or near the point of commencement of supply;
  - (b) Where a conductor forming part of a consumer's system is to be connected to the supplier's earthed or earthed neutral conductor, at the point where such connection is to be made;
  - (c) In all other cases, at the point corresponding to the point or commencement of supply or at such other point as may be approved by an Inspector.

### **Rule-31 : Cut-out on Consumer's Premises :**

- (i), 'The supplier shall provide a suitable cut-out in each conductor of every service line other than earthed or earthed neutral conductor or the earthed) conductor of a concentric cable with in a consumer's premises, in position. Such cut-out shall be contained within an adequately enclosed fireproof receptacle.



## **Electrical Installation and Estimation (EE3105PE)**

---

- Where more than one consumer is supplied through a common service line, each such consumer shall be provided with an independent cut-out at the point of junction to the common service.
- (ii) Every electricity supply line other than the earthed or earthed neutral conductor of any system or the earthed external conductor of a concentric cable shall be protected by a suitable cut-out by its owner.
- **Rule-32 : Identification of Earthed Neutral Conductor and Position of Switches and Cut-out Therein :**
- Where the conductors include an earthed conductor of a two-wire system or an earthed neutral conductor of a multi-wire system or a conductor which is to be connected there to, the following conditions shall be complied with.
- (i) An indication of a permanent nature shall be provided by the owner of the earthed or earthed neutral conductor, or the conductor which is to be connected there to, to enable such conductor to be distinguished from any live conductor.
- Such indication shall be provided :
  - (a) Where the earthed or earthed neutral conductor is the property of the supplier, at or near the point of commencement of supply;
  - (b) Where a conductor forming part of a consumer's system is to be connected to the supplier's earthed or earthed neutral conductor, at the point where such connection is to be made;
  - (c) In all other cases, at the point corresponding to the point or commencement of supply or at such other point as may be approved by an Inspector.

### **Rule-33 : Earthed Terminal on Consumer's Premises :**

- (i) The supplier shall provide and maintain on the consumer's premises for the consumer's use a suitable earthed terminal in an accessible position at or near the point of commencement of supply as defined under Rule 58.
- (ii) The consumer shall take all reasonable precautions to prevent mechanical damages to the earthed terminal and its lead belongings to the supplier.
- (iii) The supplier may recover from the consumer the cost of installation on the basis of the schedule of charges notified in advance, and there such schedule of charges is not notified.

### **Rule 34: Accessibility of Bare Conductors :**

- Where bare conductors are used in building, the owner of such conductors shall.
  1. Ensure that they are inaccessible;

## **Electrical Installation and Estimation (EE3105PE)**

---

2. Provide in readily assessable position switches for rendering them dead whenever necessary; and
3. Take such other safety measure as are considered necessary by the Inspector

• **Rule-35 : Danger Notices :**

- owner of every medium, high and extra-high voltage installation shall affix permanently in a conspicuous position a [Danger] notice in Hindi or English and the local language of the district, with a sign of skull and bones [of design as per the relevant ISS No. 2551] on:
  1. Every motor, generator, transformer and other electrical plant and equipment together with apparatus used for controlling or regulating the same;
  2. All supports of high and extra-high voltage overhead lines which can be easily climbed upon without the aid of ladder or special appliances.

**Rule-36 : Handling of Electric Supply Lines and Apparatus :**

1. Before any conductor or apparatus is handled, adequate precautions shall be taken, by earthing or other suitable means, to discharge electricity such conductor or apparatus and any adjacent conductor or apparatus if there is danger therefrom, and to prevent any conductor or apparatus from being accidentally or inadvertently electrically charged when Persons are working thereon.
2. Every person who is working on an electric Supply line or apparatus or both shall be provided with tools and devices such as gloves, rubber shoes, safety belts, ladders, earthing devices, helmets, line testers, hand lines and the like for protecting him from mechanical and electrical injury. Such tools and devices if shall always be maintained in sound and efficient working conditions.
3. No person shall work on any live electric supply line or apparatus and no person shall assist such person on such work, unless he is authorized in that behalf and takes the safety measures approved by the Inspector.
4. Every telecommunication line on supports carrying a high or extra-high voltage lines shall, for the purpose of working thereon, be deemed to be a high voltage line.

**Rule-36 : Handling of Electric Supply Lines and Apparatus :**

1. Before any conductor or apparatus is handled, adequate precautions shall be taken, by earthing or other suitable means, to discharge electricity such conductor or apparatus and any adjacent conductor or apparatus if there is danger therefrom, and to prevent any conductor or apparatus from being accidentally or inadvertently electrically charged when Persons are working thereon.

## **Electrical Installation and Estimation (EE3105PE)**

---

2. Every person who is working on an electric Supply line or apparatus or both shall be provided with tools and devices such as gloves, rubber shoes, safety belts, ladders, earthing devices, helmets, line testers, hand lines and the like for protecting him from mechanical and electrical injury. Such tools and devices if shall always be maintained in sound and efficient working conditions.
3. No person shall work on any live electric supply line or apparatus and no person shall assist such person on such work, unless he is authorized in that behalf and takes the safety measures approved by the Inspector.
4. Every telecommunication line on supports carrying a high or extra-high voltage lines shall, for the purpose of working thereon, be deemed to be a high voltage line.

### **Rule-37 : Supply to Vehicles, Cranes, etc., :**

1. Every person owning a vehicle, travelling crane or the like to which energy is supplied from an external source shall ensure that it is efficiently controlled by a suitable switch enabling all voltage to be cut-off in one operation and where such vehicle, travelling crane or the like runs on metal rails, the owner shall ensure that the rails are electrically continuous and earthed.

### **Rule-38 :Cables for Portable or Transportable Apparatus :**

1. Flexible cables shall not be used for portable or transportable motors, generators, transformers, rectifiers, electric drills, electric sprays, welding sets or any other portable or transportable apparatus unless they are heavily insulated and adequately protected from mechanical injury.
2. Where the protection is by means of metallic covering, the covering shall be in metallic connection with the frame of any such apparatus and earth.
3. The cables shall be three core type and four core type for portable and transportable apparatus working on single phase and three phase supply respectively and the wire meant to be used for ground connection shall be easily identifiable.

### **Rule-39 :Cables Protected by Bituminous Materials :**

1. Where the supplier or the owner has brought into use and electric supply line(other than on over-head line) which is not completely enclosed in a continuous metallic covering connected with earth and is insulated or protected in situ by composition of material of a bituminous character:
2. It shall not be permissible for the supplier or the own after the coming into force of these rules, to bring into use any further electric supply line as aforesaid which is insulated or protected in situ by any composition or material known to liable to produce noxious or explosive gases on excessive heating.

### **Rule-40 : Street Boxes :**

## **Electrical Installation and Estimation (EE3105PE)**

---

3. Street boxes shall not contain gas pipes and precautions shall be taken to Prevent as far as reasonably possible, any influx of water or gas.
4. Where electric supply lines forming part of different systems pass through the same street box they shall be readily distinguishable from one another and all electric supply lines at high or extra-high voltage in street boxes shall be adequately supported and protected so as to prevent risk of damages or danger from adjacent electric supply lines.
5. All street boxes shall be regularly inspected for the purpose of detecting the presence of gas and if any influx or accumulation is discovered, the owner shall give immediate notice to any authority or company who have gas mains in the neighbourhood of the street box and in cases where a street box is large enough to admit the entrance of a person after the electric supply lines or apparatus therein have been placed in position, ample provision shall be made:

### **Rule-41 : Distinction of Different Circuits :**

1. The owner of every generating station, sub-station, junction-box or pillar in which there are any circuits or apparatus, [whether intended for operation at different voltages or at the same voltage], shall ensure by means of indication of a permanent nature, that the respective circuits are readily distinguishable from one another.

### **Rule-42 :Accidental Charge :**

1. The owner of all circuits and apparatus shall so arrange them that there shall be no danger of any part thereof becoming accidentally charged to any voltage beyond the limits of voltage for which they are intended. Where AC and DC circuits and installed on the same support they shall be so arranged and protected that they shall not come into contact with each other when live.

### **Rule-43 : Provisions Applicable to Protective Equipment :**

1. Fire buckets filled with clean dry sand and ready for immediate use for extinguishing fires, in addition to fire extinguisher suitable for dealing with electric fires, shall be conspicuously marked and kept in all generating stations, [enclosed sub-station and switch station] in convenient situations. The fire extinguishers shall be tested for satisfactory operation at least once @year and record of such tests shall be maintained.
2. First-aid boxes or cupboards, conspicuously marked and equipped with such contents as the state Government may specify, shall be provided and maintained in every generating station enclosed sub-station and enclosed switch-station so as to be readily accessible during all working hours.

### **Rule-44 :Instructions for Restoration of Persons Suffering from Electric Shock :**

## **Electrical Installation and Estimation (EE3105PE)**

---

1. Instructions, in (English or Hindi and local language of the district, and where Hindi the local language, in English and Hindi) for the restoration of persons suffering from electric shock, shall be affixed by the owner in a conspicuous place in every generating station, enclosed switch-station and in every factory as defined in clause (m) of section 2 of the Factories Act, 1948 (LXIII of 1948).
2. Copies of the instructions shall be supplied on demand by an officer or officers appointed by the Central or the State Government in this behalf at a price to be fixed by the Central Government.
3. The owner of every generating station, enclosed sub-station, enclosed switch-station, and every factory or other premises to which this rule applies, shall ensure that all authorised persons employed by him acquainted with and are competent to apply the instructions.
4. In every manned high voltage or extra-voltage generating station, sub-station or switch-station, an artificial respirator shall be provided and kept in goods working condition.

### **Rule-45 :Precautions to be Adopted by Consumers, Owners, (Occupiers), Electrical Contractors, Electrical Workmen and Suppliers :**

1. No electrical installation work, including additions, alternations, repairs and adjustments to existing installations, except such replacement of lamps, fans, fuses, switches, low voltage domestic appliances and fittings as in no way alters its capacity or character, shall be carried out upon the premises of or on behalf of any [consumer, supplier, owner of occupier], for the purpose of supply to such consumer, owner, [or occupier] except an electrical contractor licenced in this behalf by the State Government and under direct supervision of a person holding a certificate of competency [and by a person holding a permit] issued or recognized by the State Government.
2. No electrical installation work which has been carried out in contravention of sub-rule (i) shall either be energised or connected to the works of any supplier.

### **Rule:46 :Periodical Inspection and Testing of Consumer's Installation :**

1. Where an installation is already connected to the supply system of the supplier, every such installation shall be periodically inspected and tested at intervals not exceeding five years either by the Inspector [or any officer appointed to assist the Inspector] or by the supplier as may be directed by the State Government in this behalf or [in the case or installations belonging to, or under the control of the Central Government, and] in the case of installations in mines, oil fields and railways, by the Central Government.

## **Electrical Installation and Estimation (EE3105PE)**

---

2. The fees for such inspection and test shall be determined by the Central or the State Government, as the case may be, in the case of each class of the consumers and shall be payable by the consumer in advance.
3. Notwithstanding the provisions of this rules, the consumers shall at all times be solely responsible for the maintenance of his installation in such condition as to be free from danger.

### **GENERAL CONDITIONS RELATING TO SUPPLY AND USE OF ENERGY**

#### **Rule-47 :Testing of Consumer's Installation :**

- Upon receipt of an application for a new additional supply of energy and before connecting the supply or reconnecting the same after a period of six months, the supplier shall inspect and test the applicant's installation.
- The supplier shall maintain a record of test results obtained at each supply point to a consumer, in a form to be approved by the Inspector.
- If as a result of such inspection and test, the supplier is satisfied that the installation is likely to constitute danger, he shall serve on the applicant a notice in writing requiring him to make such modifications as are necessary to render the installation safe. The supplier may refuse to connect or reconnect until the required modifications have been completed and he has been notified by the applicant.

#### **Rule-48 :Precautions Against Leakage Before Connection :**

- I. The supplier shall not connect with his works the installation or apparatus on the premises of any applicant for supply unless he is reasonably satisfied that the connection will not at the time of making the connection, cause a leakage from the installation or apparatus of a magnitude detrimental to safety. Compliance with the rule shall be checked by measuring the insulation resistance as provided below:
  - (a) High voltage equipments/installations :
    - 1. High voltage equipments shall have the IR value as stipulated in the relevant Indian Standard.
    - 2. At the pressure of 1000 V applied between each live conductor and earth for a period of one minute the insulation resistance of HV installations shall be at least 1 mega ohm or as specified by the [Bureau of Indian Standards] from time to time.
  - (b) Medium and low voltage installation : at a pressure of 500 V applied between each live conductor and earth for a period of one minute, the insulation resistance of medium and low voltage installation shall be at least 1 mega ohm or as specified by the [Bureau of Indian Standards] from time to time.



## **Electrical Installation and Estimation (EE3105PE)**

---

- II. If the supplier declines to make a connection under the provisions of sub-rule (i), he shall serve upon the applicant a notice in writing stating his reason for so declining.

### **Rule-49 :Leakage on Consumer's Premises :**

If the Inspector or any officer appointed to assist the Inspector and or the supplier has reason to believe that there is in the system of a consumer leakage which is likely to affect injuriously the use of energy by the supplier or by the other persons, or which is likely to cause danger, he may give the consumer reasonable notice in writing that he desire inspect and test the consumer's installation.

If, on such notice being give :

- (a) The consumer does not give all reasonable facilities for inspection and testing of this installation, or
- (b) a leakage exceeding 5000" part of the maximum current supplied to the consumer's installation.

### **Rule-50 :Supply and Use of Energy :**

- The energy shall not be supplied, transformed, converted or used or continued to be supplied, transformed, converted or used unless provisions as set out between are observed:
- (a) The following controls of requisite capacity to carry and break the current [are placed] after the point of commencement of supply as defined in Rule 58, so as to be readily, accessible and capable of being easily operated to completely isolate the supply to the installation, such equipment being in addition to any equipment installed for controlling individual circuit or apparatus:

### **Rule-51 :(A) Additional Provisions for Supply and Use of Energy in Multi-Storeyed Building (More than 15 Metres in Height) :**

- i. Before making an application for commencement of supply or recommencement of supply after an installation has been disconnected for a period of six months or more the owner/occupier of a multi-storeyed building shall give not less than 30 days notice in writing to Inspector together with particulars. The supply of energy shall not be commenced or recommenced within this period, without the approval or otherwise in writing of the Inspector;
- ii. The supplier/owner of the installation shall provide at the point of commencement of supply a suitable insulation device with cut-out or breaker to operate on all phase except neutral in the three phase four circuit and fixed in conspicuous position at not more than 2.75 metres above the ground so as to completely isolate the supply to the building in case of emergency.

## **Electrical Installation and Estimation (EE3105PE)**

---

### **Rule:51 Provisions Applicable to Medium, High or Extra-high Voltage Installations**

:

- i. The following provisions shall be observed where energy at medium, high or extra - high voltage is supplied, converted, transformed or used :
- ii. (i) (a) All conductors (other than those of overhead lines) shall be completely enclosed in mechanically strong metal casing or metallic covering which is electrically and mechanically continuous and adequately protected against mechanical damage unless the said conductors are accessible only to an authorized person or are installed and protected to the satisfaction of the inspector so as to prevent danger.
- iii. (b) All metal works, enclosing, supporting or associated with the installation, other than that designed to serve as a conductor shall be connected with an earthing system as per standards laid down in the Indian Standards in this regard.
- iv. (c) In case of installation provided in premises where inflammable materials including gases and / or chemicals are produced, handled or stored, the electrical installations, equipment and apparatus shall comply with the of flame proof, dust tight, totally enclosed or any other suitable requirements as per the type of electrical fittings depending upon the hazardous on relevant Indian Standard Specifications.

### **Rule-52 : Appeal to Inspector in Regard to Defects :**

- i. In any applicant for a supply or a consumer is dissatisfied with the action of the supplier in declining to commence, to continue or to recommence the supply of energy to his premises on the grounds that the installation is defective or is likely to constitute danger, he may appeal to the Inspector to test the installation and the supplier shall not, if the Inspector or, under his orders, any other officer appointed to assist the Inspector is satisfied that the installation is free from the defect or danger complained of, be entitled to refuse supply to the consumer on the grounds aforesaid, and shall, within twenty - four hours after the receipt of such intimation from the Inspector, commence, continue or recommence the supply of energy.
- ii. An test for which application has been made under the provision of sub-rule (i) shall be carried out within seven days after the receipt of such application.
- iii. This rule shall be endorsed on every notice given under provisions of rules 47,48 and 49.

### **Rule-53 : Cost of Inspection and Test of Consumer's Installation :**

- i. The cost of the first inspection and test of a consumer's installation carried out in pursuance of the provisions of rule 47 shall be borne by the supplier and the cost of every subsequent inspection and test shall be borne by the consumer unless in the appeal under rule 52, the Inspector directs otherwise.

## **Electrical Installation and Estimation (EE3105PE)**

---

- ii. The cost of any inspection and test made by the Inspector, [or any officer appointed to assist the Inspector], at the request of the consumer or other interested party, shall be borne by the consumer or other interested party, unless the Inspector directs otherwise.
- iii. The cost of each and every such inspection and test by whomsoever borne shall be calculated in accordance with the scale specified by the Central or the State Government as the case may be in this behalf.
- iv. **Rule : 54 Declared Voltage of Supply to Consumer :**
- v. Except with the written consent of the consumer or with the previous sanction of the State Government a supplier shall not permit the voltage at the point of commencement of supply as defined under rule 58 to vary from the declared voltage :
- vi. In the case of low or medium voltage, by more than 6 percent; or
- vii. In the case of high voltage, by more than 6% on their higher side or by more than 9% on the lower side; or
- viii. In the case of extra high voltage, by more than 10% on the higher side or by more than 12.5% on the lower side.
- ix. Provided that in the case of high voltage, the voltage variation limit of 12.5 % may continue till the 315 March, 1974.
- x. **Rule-55 : Declared Frequency of Supply to Consumer :**
- xi. Except with the written consent of the consumer or with the previous sanction of the State Government a supplier shall not permit the frequency of an alternating current supply to vary from the declared frequency by more than 3 %.
- xii. **Rule-56 : Sealing of Meters and Cut-outs :**
- xiii. (i) A supplier may affix one or more seals to any cum maximum demand indicator, or other apparatus premises in accordance with section 26, and no person other than the sup shall break any such seal.
- xiv. (ii) The consumer shall use all reasonable means in his power to ensure such seal is broken otherwise than by the supplier.
- xv. (iii) The word “Supplier” shall for the purpose of this rule include a State Government when any meter, maximum demand indicator or other apparatus is placed upon a consumer’s premises by such government.
- xvi. **Rule-57: Meters, Maximum Demand Indicators and other Consumer’s Premises :**

## **Electrical Installation and Estimation (EE3105PE)**

---

- xvii. Any meter or Demand indicator or other apparatus placed upon a consumer's premises in accordance with section 26 shall be of appropriate capacity and shall be deemed to be correct if its limits of error do not exceed 3 per cent, above or below absolute accuracy at all loads in excess of one tenth of full loads and up to full load :
- xviii. (ii) No meter shall register at no load.
- xix. (iii) Every supplier shall provide and maintain in proper condition such suitable apparatus as may be prescribed or approved by the Inspector examination, testing and regulation of meters used or intended to be used in connection with the supply of energy :
- xx. Iv) Every supplier shall examined, test and regulate all meters, maximum demand indicators and other apparatus for ascertaining the amount of energy supplied before their first installation at the consumer's premises and at such other intervals as maybe directed by the State Government in this behalf.
- xxi. **Rule-59 :Precautions Against Failure of Supply - Notice of Failures :**
- xxii. The layout of the electric supply lines of the supplier for the supply of energy throughout his area of supply shall under normal working conditions be sectionalised and so arranged, and provided with cut-outs or circuit-breakers so located, as to restrict within reasonable limits the extent of the portion of the system affected by any failure of supply.
- xxiii. The supplier shall take all reasonable precautions to avoid any accidental interruptions of supply, and also to avoid danger to the public or to any employee or authorized person when engaged or any operation during and in connection with the installation extension, replacement, repair and maintenance of any works. The supplier shall send to the Inspector [or any officer of a specified rank and class appointed to assist the Inspector] notice of failure of supply of such kind as the Inspector may from time to time require to be notified to him, and such notice shall be sent by the earliest practicable post after the failure occurs or after the failure becomes known to the supplier and shall be in such form and contain such particulars as the Inspector may from time to time specify.
- **14. ELECTRIC SUPPLY LINES, SYSTEMS AND APPARATUS FOR LOW AND MEDIUM VOLTAGES****Rule-60 : Test for Resistance of Insulation :**
  - Where any electric supply line for use at low or medium voltage has been disconnected from a system for the purpose of addition or alternation or repair, such electric supply line shall not be reconnected to the system until the supplier or the owner has applied the test prescribed under rule 48.
  - The provisions of sub-rule (i) shall not apply to overhead lines except, overhead insulated cables unless the Inspector otherwise directs in any particular case.

## **Electrical Installation and Estimation (EE3105PE)**

---

- **Rule-61 :Connection with Earth :**

- The following provisions shall apply to the connection with earth of systems at low voltage in cases where the voltage normally exceeds 125 volts and of systems at medium voltage :
- (a) Neutral conductor of a 3-phase, 4 wire system and the middle conductor of a 2-phase, 3 wire system shall be earthed by not less than two separate and distinct connections with a minimum of two different earth electrodes or such large number as may be necessary to bring the earth resistance to a satisfactory value both at the generating station and at the sub - station. The earth electrodes so provided, may be inter connected to reduce earth resistance. It may also be earthed at one or more points along the distribution system or service line in addition to any connection with earth which may be at the consumer's premises.
- (b) In the case of a system comprising electric supply lines having concentric cables, the external conductor of such cables shall be earthed by two separate and distinct connections with earth.
- (c) The connection with earth may include a link by means of which the connection may be temporarily interrupted for the purpose of testing or for locating a fault.

- **Rule-62 : System at Medium Voltage :**

- When a medium voltage supply system is employed, the voltage between earth and any conductor forming part of the same system shall not, under normal conditions, exceed low voltage.