

UNIT-I INTRODUCTION

From the beginning of history, human sensitivity has revealed an urge for mobility leading to a measure of Society's progress. The history of this mobility or transport is the history of civilization. For any country to develop with right momentum modern and efficient Transport as a basic infrastructure is a must. **Transport** (British English) or **transportation** (American English) is the movement of people and goods from one place to another. The term is derived from the Latin *trans* ("across") and *portare* ("to carry").

Means of Transport

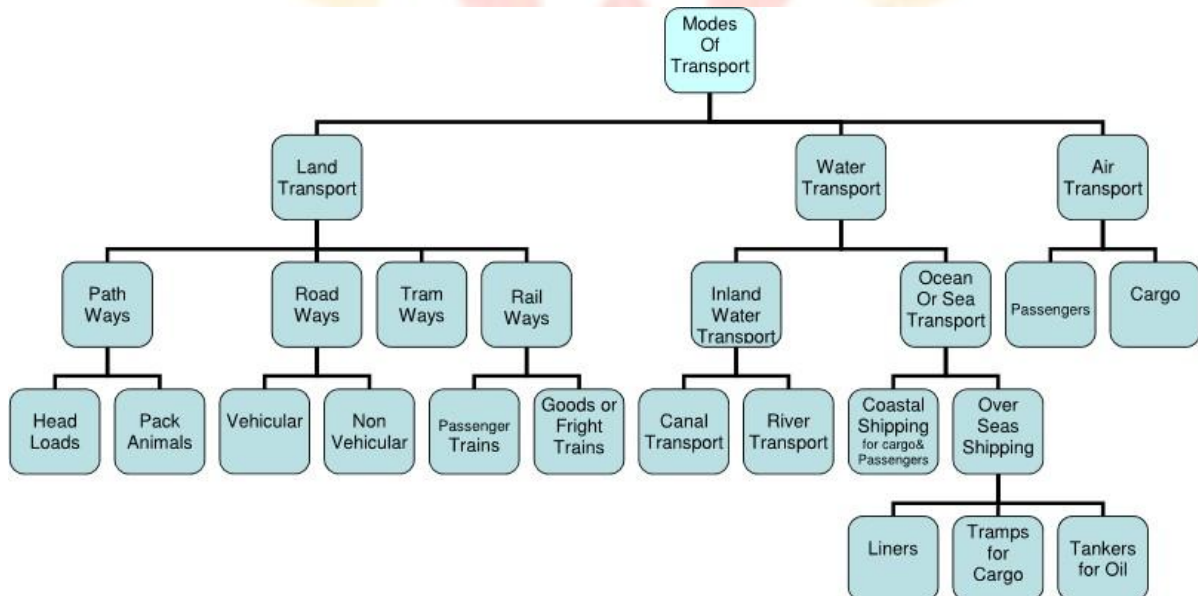

Fig.1 Means of Transport

Advantage and Disadvantage Different Modes of Transport

(A) Road Transport

Advantages	Disadvantages
<ol style="list-style-type: none"> 1. Less Capital Outlay 2. Door to Door Service 3. Service in Rural Areas 4. Flexible Service 5. Suitable for Short Distance 6. Lesser Risk of Damage in Transit 7. Saving in Packing Cost 8. Rapid Speed 9. Less Cost 	<ol style="list-style-type: none"> 1. Seasonal Nature 2. Accidents and Breakdowns 3. Unsuitable for Long Distance and Bulky Traffic 4. Slow Speed 5. Lack of Organisation

- | | |
|--|--|
| 10. Private Owned Vehicles
11. Feeder to other Modes of Transport | |
|--|--|

(B) Railway Transport

Advantages	Disadvantages
1. Dependable 2. Better Organised 3. High Speed over Long Distances 4. Suitable for Bulky and Heavy Goods 5. Cheaper Transport 6. Safety 7. Larger Capacity 8. Public Welfare 9. Administrative Facilities of Government 10. Employment Opportunities	1. Huge Capital Outlay 2. Lack of Flexibility 3. Lack of Door to Door Service 4. Monopoly 5. Unsuitable for Short Distance and Small Loads 6. Booking Formalities 7. No Rural Service 8. Under-utilised Capacity 9. Centralised Administration

(C) Air Transport

Advantages	Disadvantages
1. High Speed 2. Comfortable and Quick Services 3. No Investment in Construction of Track 4. No Physical Barriers 5. Easy Access 6. Emergency Services 7. Quick Clearance 8. Most Suitable for Carrying Light Goods of High Value 9. National Defence 10. Space Exploration	1. Very Costly 2. Small Carrying Capacity 3. Uncertain and Unreliable 4. Breakdowns and Accidents 5. Large Investment 6. Specialised Skill 7. Unsuitable for Cheap and Bulky Goods 8. Legal Restrictions

Elements of transport

The movement of goods or passenger traffic, through rail, sea, air or road transport requires adequate infrastructure facilities for the free flow from the place of origin to the place of destination. Irrespective of modes, every transport system has some common elements:

- a) Vehicle or carrier to carry passenger or goods
- b) Route or path for movement of carriers
- c) Terminal facilities for loading and unloading of goods and passengers from carriers
- d) Prime Mover
- e) Transit time and cost
- f) Cargo

These elements influence the effectiveness of different modes of transport and their utility to users.

- **Vehicles:** The dimension of vehicles, its capacity and type are some of the factors, which influence the selection of a transport system for movement of goods from one place to the other.
- **Routes:** Routes play an important role in movement of carriers from one point to another point. It may be surface roads, navigable waterways and roadways. Availability of well-designed and planned routes without any obstacle for movement of transport vehicles in specific routes, is a vital necessity for smooth flow of traffic.
- **Terminal Facilities:** - The objective of transportation can't be fulfilled unless proper facilities are available for loading and unloading of goods or entry and exit of passengers from carrier. Terminal facilities are to be provided for loading and unloading of trucks, wagons etc on a continuous basis.
- **Prime Mover:** - The power utilized for moving of vehicles for transportation of cargo from one place to another is another important aspect of the total movement system.
- **Transit time and cost:** - Transportation involve time and cost. The time element is a valid factor for determining the effectiveness of a particular mode of transport. The transit time of available system of transportation largely determines production and consumption pattern of perishable goods in an economy.
- **Cargo:** - Transportation basically involves movement of cargo from one place to another. Hence, nature and size of cargo constitute the basis of any goods transport system.

Major disciplines of transportation

Transportation engineering can be broadly consisting of the four major parts:

1. Transportation Planning
2. Geometric Design
3. Pavement Design
4. Traffic Engineering

History of highway engineering

The history of highway engineering gives us an idea about the roads of ancient times. Roads in Rome were constructed in a large scale and it radiated in many directions helping them in military operations. Thus they are considered to be pioneers in road construction. In this section we will see in detail about Ancient roads, Roman roads, British roads, French roads etc.

Ancient Roads

The most primitive mode of transport was by foot. These human pathways would have been developed for specific purposes leading to camp sites, food, streams for drinking water etc. The invention of wheel in Mesopotamian civilization led to the development of animal drawn vehicles. To provide adequate strength to carry the wheels, the new ways tended to follow the sunny drier side of a path. After the invention of wheel, animal drawn vehicles were developed and the need for hard surface road emerged. Traces of such hard roads were obtained from various ancient civilization dated as old as 3500 BC. The earliest authentic record of road was found from Assyrian empire constructed about 1900 BC.

Roman roads

The earliest large scale road construction is attributed to Romans who constructed an extensive system of roads radiating in many directions from Rome. Romans recognized that the fundamentals of good road construction were to provide good drainage, good material and good workmanship. Their roads were very durable, and some still exist. The roads were bordered on both sides by longitudinal drains. A typical cross section is shown in Fig.2.1. This was a raised formation up to a 1 meter high and 15 m wide and was constructed with materials excavated during the side drain construction. This was then topped with a sand leveling course. In the case of heavy traffic, a surface course of large 250 mm thick hexagonal stones were provided They mixed lime and volcanic puzzolana to make mortar and they added gravel to this mortar to make concrete. Thus concrete was a major Roman road making innovation.

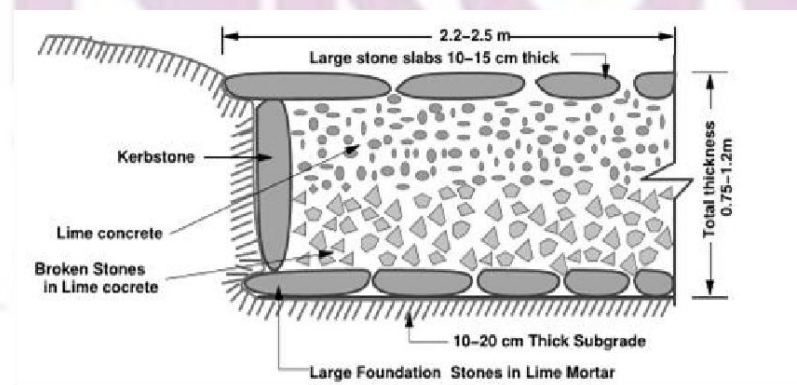

Fig.2 Roman roads

French roads

The significant contributions were given by Tresaguet in 1764 and a typical cross section of this road is given in Figure 2.2. He developed a cheaper method of construction than the lavish and locally unsuccessful revival of Roman practice. The pavement used 200 mm pieces of quarried stone of a more compact form and shaped such that they had at least one at side which was placed on a compact formation. Smaller pieces of broken stones were then compacted into the spaces between larger stones to provide a level surface. Finally the running layer was made with a layer of 25 mm sized broken stone. All this structure was placed in a trench in order to keep the running surface level with the surrounding country side. This created major drainage problems which were counteracted by making the surface as impervious as possible, cambering the surface and providing deep side ditches.

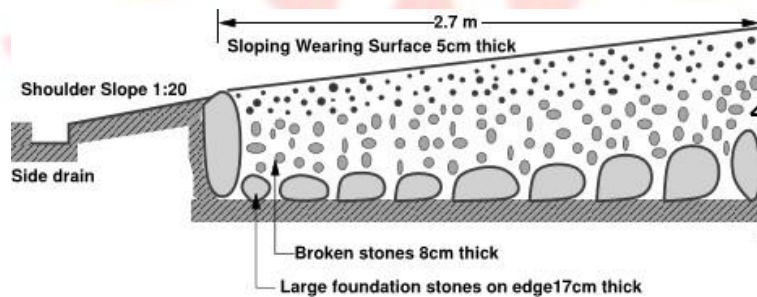

Fig. 3 French roads

British roads

The British government also gave importance to road construction. The British engineer John Macadam introduced what can be considered as the first scientific road construction method. Stone size was an important element of Macadam recipe. By empirical observation of many roads, he came to realize that 250 mm layers of well compacted broken angular stone would provide the same strength a better running surface than an expensive pavement founded on large stone blocks. Thus he introduced an economical method of road construction. A typical cross section of British roads is given in Fig. 2.3.

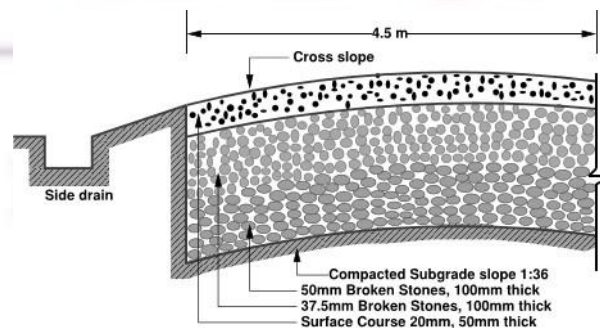

Fig. 4 British roads

Modern roads

The modern roads by and large follow Macadam's construction method. Use of bituminous concrete and cement concrete are the most important developments. Development of new equipments helps in the faster construction of roads. Many easily and locally available materials are tested in the laboratories and then implemented on roads for making economical and durable pavements.

Road Development in India

Excavations in the sites of Indus valley revealed the existence of planned roads in India as old as 2500-3500 BC. The Mauryan kings also built very good roads. During the time of Mughal period, roads in India were greatly improved. Roads linking North-West and the Eastern areas through gangetic plains were built during this time. The construction of Grand-Trunk road connecting North and South is a major contribution of the British.

Modern developments

The First World War period and that immediately following it found a rapid growth in motor transport. So need for better roads became a necessity. For that, the Government of India appointed a committee called Road development Committee with Mr.M.R. Jayakar as the chairman. This committee came to be known as Jayakar committee.

Jayakar Committee

In 1927 Jayakar committee for Indian road development was appointed. The major recommendations and the resulting implementations were:

- ✓ Committee found that the road development of the country has become beyond the capacity of local governments and suggested that Central government should take the proper charge considering it as a matter of national interest.
- ✓ They gave more stress on long term planning programme, for a period of 20 years (hence called twenty year plan) that is to formulate plans and implement those plans within the next 20 years.
- ✓ One of the recommendations was the holding of periodic road conferences to discuss about road construction and development. This paved the way for the establishment of a semi-official technical body called Indian Road Congress (IRC) in 1934
- ✓ The committee suggested imposition of additional taxation on motor transport which includes duty on motor spirit, vehicle taxation, license fees for vehicles

plying for hire. This led to the introduction of a development fund called Central road fund in 1929. This fund was intended for road development.

- ✓ The committee suggested imposition of additional taxation on motor transport which includes duty on motor spirit, vehicle taxation, and license fees for vehicles plying for hire. This led to the introduction of a development fund called Central road fund in 1929. This fund was intended for road development.

Nagpur road congress 1943

A twenty year development programme for the period (1943-1963) was finalized. It was the first attempt to prepare a co-ordinated road development programme in a planned manner.

The roads were divided into four classes:

- **National highways** which would pass through states, and places having national importance for strategic, administrative and other purposes.
- **State highways** which would be the other main roads of a state.
- **District roads** which would take traffic from the main roads to the interior of the district. According to the importance, some are considered as **major district roads** and the remaining as **other district roads**.
- **Village roads** which would link the villages to the road system.

The committee planned to construct 2 lakh kms of road across the country within 20 years. They recommended the construction of star and grid pattern of roads throughout the country. One of the objective was that the road length should be increased so as to give a road density of 16kms per 100 sq.km

Bombay road congress 1961

The length of roads envisaged under the Nagpur plan was achieved by the end of it, but the road system was deficient in many respects. Accordingly a 20-year plan was drafted by the Roads wing of Government of India, which is popularly known as the Bombay plan. The highlights of the plan were:

- It was the second 20 year road plan (1961-1981)
- The total road length targeted to construct was about 10 lakhs.
- Rural roads were given specific attention.
- They suggested that the length of the road should be increased so as to give a road density of 32kms/100 sq.km
- The construction of 1600 km of expressways was also then included in the plan.

Lucknow road congress 1984

Some of the salient features of this plan are as given below:

- This was the third 20 year road plan (1981-2001). It is also called Lucknow road plan.
- It aimed at constructing a road length of 12 lakh kilometers by the year 1981 resulting in a road density of 82kms/100 sq.km
- The plan has set the target length of NH to be completed by the end of seventh, eighth and ninth five year plan periods.
- It aims at improving the transportation facilities in villages, towns etc. such that no part of country is farther than 50 km from NH.
- One of the goals contained in the plan was that expressways should be constructed on major traffic corridors to provide speedy travel.
- Energy conservation, environmental quality of roads and road safety measures were also given due importance in this plan.

2.4 Current Scenario

About 60 per cent of freight and 87 per cent passenger traffic is carried by road. Although National Highways constitute only about 2 per cent of the road network, it carries 40 per cent of the total road traffic. Easy availability, adaptability to individual needs and cost savings are some of the factors which go in favour of road transport. Road transport also acts as a feeder service to railway, shipping and air traffic. The number of vehicles has been growing at an average pace of around 10 per cent per annum. The share of road traffic in total traffic has grown from 13.8 per cent of freight traffic and 15.4 per cent of passenger traffic in 1950-51 to an estimated 62.9 per cent of freight traffic and 90.2 per cent of passenger traffic by the end of 2009-10. The rapid expansion and strengthening of the road network, therefore, is imperative, to provide for both present and future traffic and for improved accessibility to the hinterland.

The Stages of Highway Development

Although the names may vary by State, the five basic stages in the highway development process are: planning, project development (preliminary design), final design, right of way, and construction. After construction is completed, ongoing operation and maintenance activities continue throughout the life of the facility.

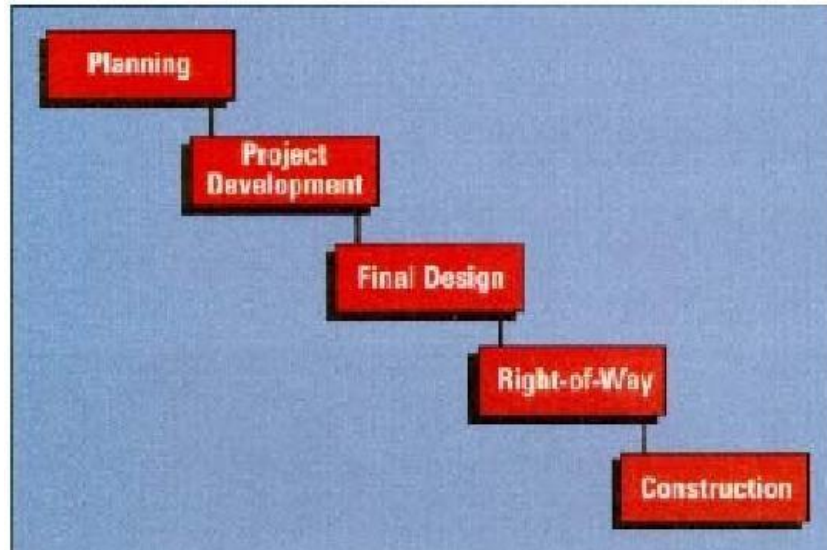

Fig.5 Process of Highway Planning

✓ **Planning**

The initial definition of the need for any highway or bridge improvement project takes place during the planning stage. This problem definition occurs at the State, regional, or local level, depending on the scale of the proposed improvement. This is the key time to get the public involved and provide input into the decision making process. The problems identified usually fall into one or more of the following four categories:

1. The existing physical structure needs major repair/replacement (structure repair).
2. Existing or projected future travel demands exceed available capacity, and access to transportation and mobility need to be increased (capacity).
3. The route is experiencing an inordinate number of safety and accident problems that can only be resolved through physical, geometric changes (safety).
4. Developmental pressures along the route make a reexamination of the number, location, and physical design of access points necessary (access).

✓ **Factors to Consider During Planning**

It is important to look ahead during the planning stage and consider the potential impact that a proposed facility or improvement may have while the project is still in the conceptual phase. During planning, key decisions are made that will affect and limit the design options in subsequent phases.



Fig. 6 Factors to consider in planning.

✓ **Project Development**

After a project has been planned and programmed for implementation, it moves into the project development phase. At this stage, the environmental analysis intensifies. The level of environmental review varies widely, depending on the scale and impact of the project. It can range from a multiyear effort to prepare an Environmental Impact Statement (a comprehensive document that analyzes the potential impact of proposed alternatives) to a modest environmental review completed in a matter of weeks. Regardless of the level of detail or duration, the product of the project development process generally includes a description of the location and major design features of the recommended project that is to be further designed and constructed, while continually trying to avoid, minimize, and mitigate environmental impact.

✓ **Final Design**

After a preferred alternative has been selected and the project description agreed upon as stated in the environmental document, a project can move into the final design stage. The product of this stage is a complete set of plans, specifications, and estimates (PS&Es) of required quantities of materials ready for the solicitation of construction bids and subsequent construction. Depending on the scale and complexity of the project, the final design process may take from a few months to several years.

The following paragraphs discuss some important considerations of design, including:

- Developing a concept
- Considering scale and
- Detailing the design.

➤ **Developing a Concept**

A design concept gives the project a focus and helps to move it toward a specific direction. There are many elements in a highway, and each involves a number of separate but interrelated

design decisions. Integrating all these elements to achieve a common goal or concept helps the designer in making design decisions.

Some of the many elements of highway design are

- a. Number and width of travel lanes, median type and width, and shoulders
- b. Traffic barriers
- c. Overpasses/bridges
- d. Horizontal and vertical alignment and affiliated landscape.

➤ **Considering Scale**

People driving in a car see the world at a much different scale than people walking on the street. This large discrepancy in the design scale for a car versus the design scale for people has changed the overall planning of our communities. For example, it has become common in many suburban commercial areas that a shopper must get in the car and drive from one store to the next.

The design element with the greatest effect on the scale of the roadway is its width, or cross section. The cross section can include a clear zone, shoulder, parking lanes, travel lanes, and/or median. The wider the overall roadway, the larger its scale; however, there are some design techniques that can help to reduce the perceived width and, thus, the perceived scale of the roadway. Limiting the width of pavement or breaking up the pavement is one option. In some instances, four lane roadways may look less imposing by designing a grass or planted median in the center.

➤ **Detailing the Design**

Particularly during the final design phase, it is the details associated with the project that are important. Employing a multidisciplinary design team ensures that important design details are considered and those they are compatible with community values. Often it is the details of the project that are most recognizable to the public. A multidisciplinary design team can produce an aesthetic and functional product when the members work together and are flexible in applying guidelines.

✓ **Right-of-way, Construction, And Maintenance**

Once the final designs have been prepared and needed right-of-way is purchased, construction bid packages are made available, a contractor is selected, and construction is initiated. During the right-of-way acquisition and construction stages, minor adjustments in the design may be necessary; therefore, there should be continuous involvement of the design team throughout these stages. Construction may be simple or complex and may require a few months to several years. Once construction has been completed, the facility is ready to begin its normal sequence of operations and maintenance.

Even after the completion of construction, the character of a road can be changed by inappropriate maintenance actions. For example, the replacement of sections of guardrail damaged or destroyed in crashes commonly utilizes whatever spare guardrail sections may be

available to the local highway maintenance personnel at the time.

❖ Stages of Highway Development

Summaries of the five basic stages in highway planning and development.

Stages	Description of Activity
Planning	Identification of transportation needs and program project to be built Within financial constraints.
Project Development	The transportation project is more clearly defined. Alternative locations and design features are developed and an alternative is selected.
Design	The design team develops detailed design and specification.
Right-of-way	Land needed for the project is acquired.
construction	Selection of contractor, who then builds the project.

Highway Route Surveys and Location

To determine the geometric features of road design, the following surveys must be conducted after the necessity of the road is decided.

A variety of survey and investigations have to be carried out by Road engineers and multidiscipline persons.

A. Transport Planning Surveys

- Traffic Surveys
- Highway inventories
- Pavement Deterioration Study
- Accident study

B. Alignment and Route location surveys

- Desk study
- Reconnaissance
- Preliminary Survey
- Final location survey

C. Drainage Studies

- Surface run- off : Hydrologic and hydraulic
- Subsurface drainage: Ground water & Seepage
- Cross-drainage: Location and waterway area required for the cross-drainage structures.

D. Soil Survey

- Desk study
- Site Reconnaissance

E. Pavement Design investigation Soil property and strength, Material Survey.

UNIT-2 GEOMETRIC DESIGN

Geometric design for transportation facilities includes the design of geometric cross sections, horizontal alignment, vertical alignment, intersections, and various design details. These basic elements are common to all linear facilities, such as roadways, railways, and airport runways and taxiways. Although the details of design standards vary with the mode and the class of facility, most of the issues involved in geometric design are similar for all modes. In all cases, the goals of geometric design are to maximize the comfort, safety, and economy of facilities, while minimizing their environmental impacts. This chapter focuses on the fundamentals of geometric design, and presents standards and examples from different modes.

The geometric design of highways deals with the dimensions and layout of visible features of the highway. The features normally considered are the cross section elements, sight distance consideration, horizontal curvature, gradients, and intersection. The design of these features is to a great extent influenced by driver behavior and psychology, vehicle characteristics, traffic characteristics such as speed and volume. Proper geometric design will help in the reduction of accidents and their severity. Therefore, the objective of geometric design is to provide optimum efficiency in traffic operation and maximum safety at reasonable cost.

The planning cannot be done stage wise like that of a pavement, but has to be done well in advance. The main components that will be discussed are:

1. Factors affecting the geometric design,
2. Highway alignment, road classification,
3. Pavement surface characteristics,
4. Cross-section elements including cross slope, various widths of roads and features in the road margins.
5. Sight distance elements including cross slope, various widths and features in the road margins.
6. Horizontal alignment which includes features like super elevation, transition curve, extra widening and set back distance.
7. Vertical alignment and its components like gradient, sight distance and design of length of curves.
8. Intersection features like layout, capacity, etc.

Factors affecting geometric design

- **Design speed:** Design speed is the single most important factor that affects the geometric design. It directly affects the sight distance, horizontal curve, and the length of vertical curves. Since the speed of vehicles vary with driver, terrain etc, a design speed is adopted for all the geometric design.
- **Topography:** It is easier to construct roads with required standards for a plain terrain. However, for a given design speed, the construction cost increases multi form with the gradient and the terrain.
- **Traffic factors:** It is of crucial importance in highway design, is the traffic data both current and future estimates. Traffic volume indicates the level of services (LOS) for which the highway is being planned and directly affects the geometric features such as width, alignment, grades etc., without traffic data it is very difficult to design any highway
- **Design Hourly Volume and Capacity:** The general unit for measuring traffic on highway is the Annual Average Daily Traffic volume, abbreviated as AADT. The traffic flow (or) volume keeps fluctuating with time, from a low value during off peak hours to the highest value during the peak hour. It will be uneconomical to design the roadway facilities for the peak traffic flow.
- **Environmental and other factors:** - The environmental factors like air pollution, noise pollution, landscaping, aesthetics and other global conditions should be given due considerations in the geometric design of roads.

Road classification

The roads can be classified in many ways. The classification based on speed and accessibility is the most generic one. Note that as the accessibility of road increases, the speed reduces. (See Fig. 4.1). Accordingly, the roads can classified as follows in the order of increased accessibility and reduced speeds.

- **Freeways:** Freeways are access controlled divided highways. Most freeways are four lanes, two lanes each direction, but many freeways widen to incorporate more lanes as they enter urban areas. Access is controlled through the use of interchanges, and the type

of interchange depends upon the kind of intersecting road way (rural roads, another freeway etc.)

- **Expressways:** They are superior type of highways and are designed for high speeds(120 km/hr is common), high traffic volume and safety. They are generally provided with grade separations at intersections. Parking, loading and unloading of goods and pedestrian traffic is not allowed on expressways.
- **Highways:** They represent the superior type of roads in the country. Highways are of two types - rural highways and urban highways. Rural highways are those passing through rural areas (villages) and urban highways are those passing through large cities and towns, i.e. urban areas.
- **Arterials:** It is a general term denoting a street primarily meant for through traffic usually on a continuous route. They are generally divided highways with fully or partially controlled access. Parking, loading and unloading activities are usually restricted and regulated. Pedestrians are allowed to cross only at intersections/designated pedestrian crossings.
- **Local streets:** A local street is the one which is primarily intended for access to residence, business or abutting property. It does not normally carry large volume of traffic and also it allows unrestricted parking and pedestrian movements.
- **Collectors streets:** These are streets intended for collecting and distributing traffic to and from local streets and also for providing access to arterial streets. Normally full access is provided on these streets. There are few parking restrictions except during peak hours.

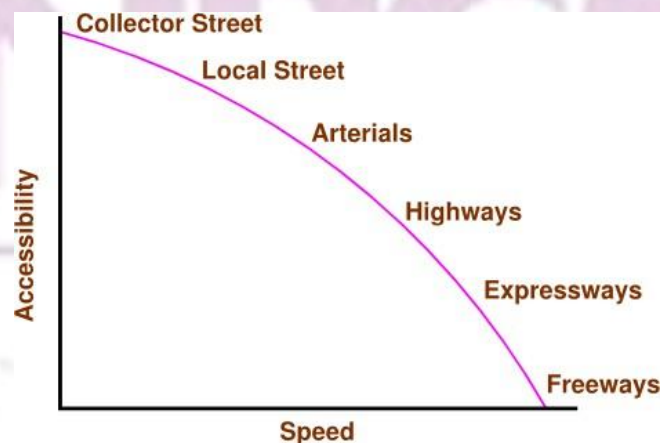

Fig.7 Speed vs accessibility

Roads can be classified based on some other criteria. They are given in detail below.

Based on usage

This classification is based on whether the roads can be used during different seasons of the year.

- All-weather roads: Those roads which are negotiable during all weathers, except at major river crossings where interruption of traffic is permissible up to a certain extent are called all weather roads.
- Fair-weather roads: Roads which are negotiable only during fair weather are called fair weather roads.

Based on carriage way

This classification is based on the type of the carriage way or the road pavement.

- Paved roads with hard surface : If they are provided with a hard pavement course such roads are called paved roads.(eg: stones, Water bound macadam (WBM), Bituminous macadam (BM), concrete roads)
- Unpaved roads: Roads which are not provided with a hard course of atleast a WBM layer they are called unpaved roads. Thus earth and gravel roads come under this category.

Based on pavement surface

Based on the type of pavement surfacing provided, they are classified as surfaced and unsurfaced roads.

- Surfaced roads (BM, concrete): Roads which are provided with a bituminous or cement concreting surface are called surfaced roads.
- Unsurfaced roads (soil/gravel): Roads which are not provided with a bituminous or cement concreting surface are called unsurfaced roads.

Other criteria

Roads may also be classified based on the traffic volume in that road, load transported through that road, or location and function of that road.

- Traffic volume: Based on the traffic volume, they are classified as heavy, medium and light traffic roads. These terms are relative and so the limits under each class may be expressed as vehicles per day.
- Load transported: Based on the load carried by these roads, they can be classified as class I, class II, etc. or class A, class B etc. and the limits may be expressed as tonnes per day.

- Location and function: The classification based on location and function should be a more acceptable classification since they may be defined clearly.

Highway alignment

Once the necessity of the highway is assessed, the next process is deciding the alignment. The highway alignment can be either horizontal or vertical and they are described in detail in the following sections.

Alignment

The position or the layout of the central line of the highway on the ground is called the alignment. Horizontal alignment includes straight and curved paths. Vertical alignment includes level and gradients. Alignment decision is important because a bad alignment will enhance the construction, maintenance and vehicle operating cost. Once an alignment is fixed and constructed, it is not easy to change it due to increase in cost of adjoining land and construction of costly structures by the roadside.

Requirements

The requirements of an ideal alignment are:

- The alignment between two terminal stations should be short and as far as possible be straight, but due to some practical considerations deviations may be needed.
- The alignment should be easy to construct and maintain. It should be easy for the operation of vehicles. So to the maximum extent easy gradients and curves should be provided.
- It should be safe both from the construction and operating point of view especially at slopes, embankments, and cutting. It should have safe geometric features.
- The alignment should be economical and it can be considered so only when the initial cost, maintenance cost, and operating cost is minimum.

Factors controlling alignment

We have seen the requirements of an alignment. But it is not always possible to satisfy all these requirements. Hence we have to make a judicial choice considering all the factors.

The various factors that control the alignment are as follows:

- **Obligatory points:** These are the control points governing the highway alignment. These points are classified into two categories. Points through which it should pass and points through which it should not pass. Some of the examples are:
 - **Bridge site:** The bridge can be located only where the river has straight and permanent path and also where the abutment and pier can be strongly founded. The road approach to the bridge should not be curved and skew crossing should be avoided as possible. Thus to locate a bridge the highway alignment may be changed.

- **Mountain:** While the alignment passes through a mountain, the various alternatives are to either construct a tunnel or to go round the hills. The suitability of the alternative depends on factors like topography, site conditions and construction and operation cost.
- **Intermediate town:** The alignment may be slightly deviated to connect an intermediate town or village nearby.

These were some of the obligatory points through which the alignment should pass. Coming to the second category that is the points through which the alignment should not pass are:

- **Religious places:** These have been protected by the law from being acquired for any purpose. Therefore, these points should be avoided while aligning.
- **Very costly structures:** Acquiring such structures means heavy compensation which would result in an increase in initial cost. So the alignment may be deviated not to pass through that point.
- **Lakes/ponds etc:** The presence of a lake or pond on the alignment path would also necessitate deviation of the alignment.
- **Traffic:** The alignment should suit the traffic requirements. Based on the origin-destination data of the area, the desire lines should be drawn. The new alignment should be drawn keeping in view the desire lines, traffic flow pattern etc.
- **Geometric design:** Geometric design factors such as gradient, radius of curve, sight distance etc. also governs the alignment of the highway. To keep the radius of curve minimum, it may be required to change the alignment of the highway. The alignments should be finalized such that the obstructions to visibility do not restrict the minimum requirements of sight distance. The design standards vary with the class of road and the terrain and accordingly the highway should be aligned.

Cross sectional elements

The primary consideration in the design of geometric cross sections for highways, run-ways, and taxiways is drainage. Details vary depending on the type of facility Highway cross sections consist of traveled way, shoulders(or parking lanes), and drainage channels. Shoulders are intended primarily as a safety feature. They provide for accommodation of stopped vehicles, emergency use, and lateral support of the pavement. Shoulders may be either paved or unpaved. Drainage channels may consist of ditches (usually grassed swales) or of paved shoulders with berms or curbs and gut-ters. Cross section of various roads are given bellow.

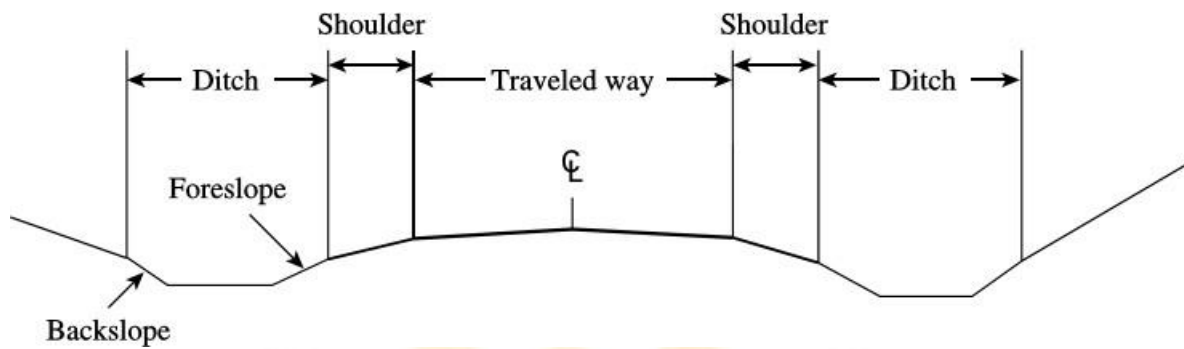

Fig.8 Two-lane highway cross section, with ditches.

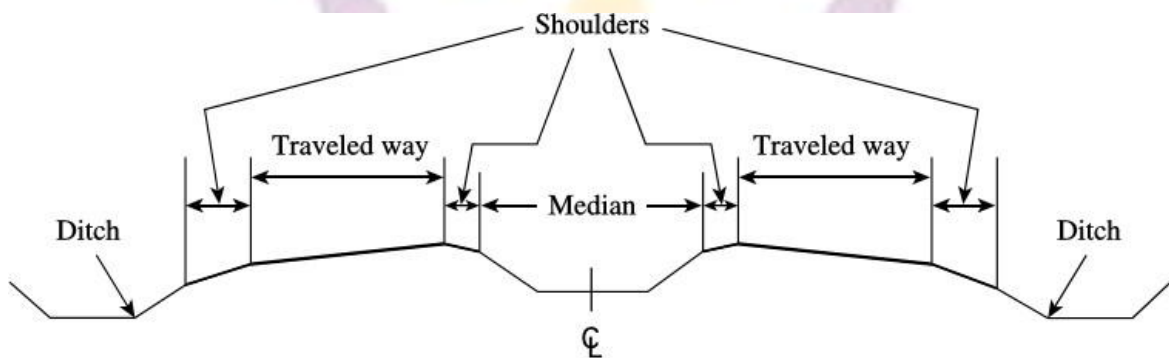

Fig.9 Divided highway cross section, depressed median, with ditches.

Pavement surface characteristics

For a safe and comfortable driving four aspects of the pavement surface are important; the friction between the wheels and the pavement surface, smoothness of the road surface, the light reflection characteristics of the top of pavement surface, and drainage to water.

Friction

Friction between the wheel and the pavement surface is a crucial factor in the design of horizontal curves and thus the safe operating speed. Further, it also affects the acceleration and deceleration ability of vehicles. Lack of adequate friction can cause skidding or slipping of vehicles.

- Skidding happens when the path traveled along the road surface is more than the circumferential movement of the wheels due to friction
- Slip occurs when the wheel revolves more than the corresponding longitudinal movement along the road. Various factors that affect friction are:

The frictional force that develops between the wheel and the pavement is the load acting

multiplied by a factor called the coefficient of friction and denoted as f . The choice of the value of f is a very complicated issue since it depends on many variables. IRC suggests the coefficient of longitudinal friction as 0.35-0.4 depending on the speed and coefficient of lateral friction as 0.15. The former is useful in sight distance calculation and the latter in horizontal curve design.

Unevenness

It is always desirable to have an even surface, but it is seldom possible to have such one. Even if a road is constructed with high quality pavers, it is possible to develop unevenness due to pavement failures. Unevenness affect the vehicle operating cost, speed, riding comfort, safety, fuel consumption and wear and tear of tyres.

Unevenness index is a measure of unevenness which is the cumulative measure of vertical undulation of the pavement surface recorded per unit horizontal length of the road. An unevenness index value less than 1500 mm/km is considered as good, a value less than 2500 mm.km is satisfactory up to speed of 100 kmph and values greater than 3200 mm/km is considered as uncomfortable even for 55 kmph.

Light reflection

Drainage

The pavement surface should be absolutely impermeable to prevent seepage of water into the pavement layers. Further, both the geometry and texture of pavement surface should help in draining out the water from the surface in less time.

Camber

Camber or cant is the cross slope provided to raise middle of the road surface in the transverse direction to drain off rain water from road surface.

Too steep slope is undesirable for it will erode the surface. Camber is measured in 1 in n or $n\%$ (Eg. 1 in 50 or 2%) and the value depends on the type of pavement surface.

Width of carriage way

Width of the carriage way or the width of the pavement depends on the width of the traffic lane and number of lanes. Width of a traffic lane depends on the width of the vehicle and the clearance. Side clearance improves operating speed and safety.

Kerbs

Kerbs indicate the boundary between the carriage way and the shoulder or islands or footpaths. Different types of kerbs are (Figure 12:3):

- Low or mountable kerbs :
- Semi-barrier type kerbs :
- Barrier type kerbs :

Road margins

The portion of the road beyond the carriageway and on the roadway can be generally called road margin. Various elements that form the road margins are given below.

- Shoulders
- Parking lanes
- Bus-bays
- Service roads
- Cycle track
- Footpath
- Guard rail

SIGHT DISTANCE

Sight Distance is a length of road surface which a particular driver can see with an acceptable level of clarity. Sight distance plays an important role in geometric highway design because it establishes an acceptable design speed, based on a driver's ability to visually identify and stop for a particular, unforeseen roadway hazard or pass a slower vehicle without being in conflict with opposing traffic. As velocities on a roadway are increased, the design must be catered to allowing additional viewing distances to allow for adequate time to stop.

Types of sight distance

- Stopping sight distance (SSD) or the absolute minimum sight distance
- Intermediate sight distance (ISD) is defined as twice SSD
- Overtaking sight distance (OSD) for safe overtaking operation

The computation of sight distance depends on:

1. Reaction time of the driver
2. Speed of the vehicle
3. Efficiency of brakes

PIEV Process

The perception-reaction time for a driver is often broken down into the four components that are assumed to make up the perception reaction time. These are referred to as the PIEV time or process.

PIEV Process

- Perception the time to see or discern an object or event
- Intellection the time to understand the implications of the object's presence or event
- Emotion the time to decide how to react
- Volition the time to initiate the action, for example, the time to engage the brakes

Stopping sight distance

Stopping sight distance is defined as the distance needed for drivers to see an object on the roadway ahead and bring their vehicles to safe stop before colliding with the object. The distances are derived for various design speeds based on assumptions for driver reaction time, the braking ability of most vehicles under wet pavement conditions, and the friction provided by most pavement surfaces, assuming good tires. A roadway designed to criteria employs a horizontal and vertical alignment and a cross section that provides at least the minimum stopping sight distance through the entire facility.

The stopping sight distance is comprised of the distance to perceive and react to a condition plus the distance to stop:

$$SSD = 0.278 Vt + \frac{v^2}{254 (f \pm g)} \quad (\text{METRIC})$$

$$SSD = 1.47 Vt + \frac{V^2}{3 (f \pm g)} \quad (\text{ENGLISH})$$

where SSD = required stopping sight distance, m or ft.

V = speed, kph or mph

t = perception-reaction time, sec., typically 2.5 sec. for design

f = coefficient of friction, typically for a poor, wet pavement

g = grade, decimal.

Overtaking sight distance

The overtaking sight distance is the minimum distance open to the vision of the driver of a vehicle intending to overtake the slow vehicle ahead safely against the traffic in the opposite direction. The overtaking sight distance or passing sight distance is measured along the center line of the road over which a driver with his eye level 1.2 m above the road surface can see the top of an object 1.2 m above the road surface.

The factors that affect the OSD are:

- Velocities of the overtaking vehicle, overtaken vehicle and of the vehicle coming in the opposite direction.
- Spacing between vehicles, which in-turn depends on the speed
- Skill and reaction time of the driver
- Rate of acceleration of overtaking vehicle

Horizontal curve

Design Speed

The design speed as noted earlier, is the single most important factor in the design of horizontal alignment. The design speed also depends on the type of the road. For e.g, the design speed expected from a National highway will be much higher than a village road, and hence the curve geometry will vary significantly.

Factors Affecting Alignment

- I. Safety
- II. Grades
- III. Design speed
- IV. Cost of resumption of land
- V. Construction costs

Operating speed is influenced by all other factors so it is the critical factor to consider.

Horizontal curve

The presence of horizontal curve imparts centrifugal force which is reactive force acting outward on a vehicle negotiating it. Centrifugal force depends on speed and radius of the horizontal curve and is counteracted to a certain extent by transverse friction between the tyre and pavement surface. On a curved road, this force tends to cause the vehicle to overrun or to slide outward from the centre of road curvature. For proper design of the curve, an understanding of the forces acting on a vehicle taking a horizontal curve is necessary.

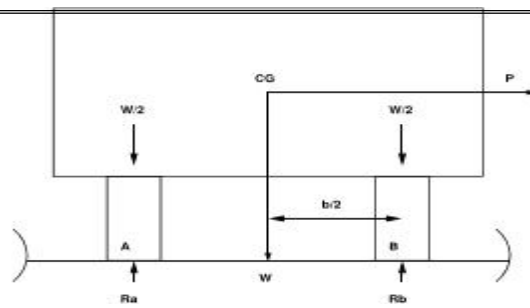

Fig. 10 Effect of horizontal curve

Super-elevation

For fast moving vehicles, providing higher superelevation without considering coefficient of friction is safe, i.e. centrifugal force is fully counteracted by the weight of the vehicle or superelevation. For slow moving vehicles, providing lower superelevation considering coefficient of friction is safe, i.e. centrifugal force is counteracted by superelevation and coefficient of friction .

Maximum Superelevation

- Max range from flat to mountainous of 0.06 – 0.12 respectively but most authorities limit to 0.10
- In urban areas limit max values to 0.04-0.05
- Minimum Superelevation
- Should be elevated to at least the cross-fall on straights i.e. 3% (0.03)

Attainment of super-elevation

1. Elimination of the crown of the cambered section by:
 - rotating the outer edge about the crown
 - shifting the position of the crown:
2. Rotation of the pavement cross section to attain full super elevation by: There are two methods of attaining superelevation by rotating the pavement

rotation about the center line :

rotation about the inner edge:

Radius of Horizontal Curve

The radius of the horizontal curve is an important design aspect of the geometric design. The maximum comfortable speed on a horizontal curve depends on the radius of the curve. Although it is possible to design the curve with maximum superelevation and coefficient of friction, it is not desirable because re-alignment would be required if the design speed is increased in future. Therefore, a ruling minimum radius R_{ruling} can be derived by assuming maximum superelevation and coefficient of friction. Ideally, the radius of the curve should be higher than R_{ruling} . However, very large curves are also not desirable. Setting out large curves in the field becomes difficult. In addition, it also enhances driving strain.

Extra widening

Extra widening refers to the additional width of carriageway that is required on a curved section of a road over and above that required on a straight alignment. This widening is done due to two reasons:

Mechanical widening

The reasons for the mechanical widening are: When a vehicle negotiates a horizontal curve, the rear wheels follow a path of shorter radius than the front wheels

Psychological widening

Widening of pavements has to be done for some psychological reasons also. There is a tendency for the drivers to drive close to the edges of the pavement on curves. Some extra space is to be provided for more clearance for the crossing and overtaking operations on curves. IRC proposed an empirical relation for the psychological.

In this section we will deal with the design of transition curves and setback distances. Transition curve ensures a smooth change from straight road to circular curves. Setback distance looks in for safety at circular curves taking into consideration the sight distance aspects.

Horizontal Transition Curves

A transition curve differs from a circular curve in that its radius is always changing. As one would expect, such curves involve more complex formulae than the curves with a constant radius and their design is more complex.

The need for Transition Curves

Circular curves are limited in road designs due to the forces which act on a vehicle as they travel around a bend. Transition curves are used to introduce those forces gradually and uniformly thus ensuring the safety of passenger.

Transition curves have much more complex formulae and are more difficult to set out on site than circular curves as a result of the varying radius.

- ✓ to introduce gradually the centrifugal force between the tangent point and the beginning of the circular curve, avoiding sudden jerk on the vehicle. This increases the comfort of passengers.
- ✓ to enable the driver turn the steering gradually for his own comfort and security,
- ✓ to provide gradual introduction of super elevation, and
- ✓ to provide gradual introduction of extra widening.

✓ to enhance the aesthetic appearance of the road.

The use of Transition Curves

Transition curves can be used to join to straights in one of two ways:

- Composite curves
- Wholly transitional curves

Types of Transition Curve

There are two types of curved used to form the transitional section of a composite or wholly transitional curve. These are:

- The clothoid
- The cubic parabola.

Length of transition curve

The length of the transition curve should be determined as the maximum of the following three criteria: rate of change of centrifugal acceleration, rate of change of superelevation, and an empirical formula given by IRC.

1. Rate of change of centrifugal acceleration
2. Rate of introduction of super-elevation
3. By empirical formula

Setback Distance

Setback distance or the clearance distance is the distance required from the centerline of a horizontal curve to an obstruction on the inner side of the curve to provide adequate sight distance at a horizontal curve. The setback distance depends on:

1. sight distance (OSD, ISD and OSD),
2. radius of the curve, and
3. length of the curve.

Curve Resistance

When the vehicle negotiates a horizontal curve, the direction of rotation of the front and the rear wheels are different. The front wheels are turned to move the vehicle along the curve, whereas the rear wheels seldom turn.

Gradient

Gradient is the rate of rise or fall along the length of the road with respect to the horizontal. While aligning a highway, the gradient is decided designing the vertical curve. Before finalizing the gradients, the construction cost, vehicular operation cost and the practical problems in the site also has to be considered. Usually steep gradients are avoided as far as possible because of the difficulty to climb and increase in the construction cost. More about gradients are discussed below.

Effect of gradient

The effect of long steep gradient on the vehicular speed is considerable. This is particularly important in roads where the proportion of heavy vehicles is significant. Due to restrictive sight distance at uphill gradients the speed of traffic is often controlled by these heavy vehicles. As a result, not only the operating costs of the vehicles are increased, but also capacity of the roads will have to be reduced. Further, due to high differential speed between heavy and light vehicles, and between uphill and downhill gradients, accidents abound in gradients.

Representation of gradient

The positive gradient or the ascending gradient is denoted as $+n$ and the negative gradient as n . The deviation angle N is: when two grades meet, the angle which measures the change of direction and is given by the algebraic difference between the two grades $(n_1 - n_2) = n_1 + n_2 = 1 + 2$. Example: 1 in 30 = 3.33% 2° is a steep gradient, while 1 in 50 = 2% $1^\circ 10'$ is flatter gradient.

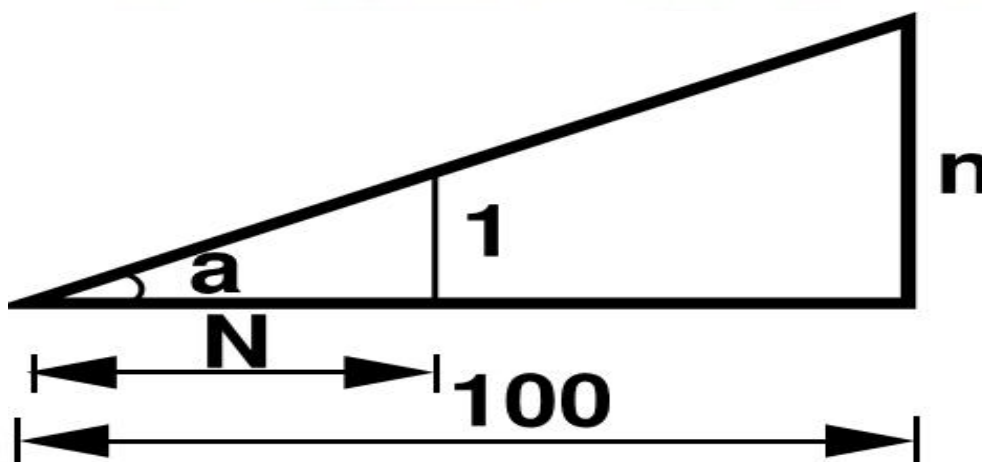

Representation of gradient

IRC Specifications for gradients for different roads

Terrain	Ruling	Limitings	Exceptional
Plain/Rolling	3.3	5.0	6.7
Hilly	5.0	6.0	7.0
Steep	6.0	7.0	8.0

Types of gradient

Many studies have shown that gradient upto seven percent can have considerable effect on the speeds of the passenger cars. On the contrary, the speeds of the heavy vehicles are considerably reduced when long gradients as at as two percent is adopted. Although, atter gradients are desirable, it is evident that the cost of construction will also be very high.

Ruling gradient

- Limiting gradient
- Exceptional gradient
- Critical length of the grade
- Minimum gradient
- Summit curve

Summit curves

Summit curves are vertical curves with gradient upwards. They are formed when two gradients meet.

1. when a positive gradient meets another positive gradient
2. when positive gradient meets a at gradient.
3. when an ascending gradient meets a descending gradient.
4. when a descending gradient meets another descending gradient.

UNIT -3

TRAFFIC ENGINEERING

Traffic stream parameters

The traffic stream includes a combination of driver and vehicle behavior.

1. Speed

Speed is considered as a quality measurement of travel as the drivers and passengers will be concerned more about the speed of the journey than the design aspects of the traffic.

- Spot Speed
- Running speed

Time mean speed and space mean speed

Time mean speed is defined as the average speed of all the vehicles passing a point on a highway over some specified time period. Space mean speed is defined as the average speed of all the vehicles occupying a given section of a highway over some specified time period.

2. Flow

There are practically two ways of counting the number of vehicles on a road. One is flow or volume, which is defined as the number of vehicles that pass a point on a highway or a given lane or direction of a highway during a specific time interval.

Types of volume measurements

- I. Average Annual Daily Traffic(AADT)
- II. Average Annual Weekday Traffic(AAWT)
- III. Average Daily Traffic(ADT)
- IV. Average Weekday Traffic(AWT)

3. Density

Density is defined as the number of vehicles occupying a given length of highway or lane and is generally expressed as vehicles per km/mile.

Derived characteristics

Time headway

The microscopic character related to volume is the time headway or simply headway. Time headway is defined as the time difference between any two successive vehicles when they cross a given point.

Distance headway

Another related parameter is the distance headway. It is defined as the distance between corresponding points of two successive vehicles at any given time.

Travel time

Travel time is defined as the time taken to complete a journey.

Time-space diagram

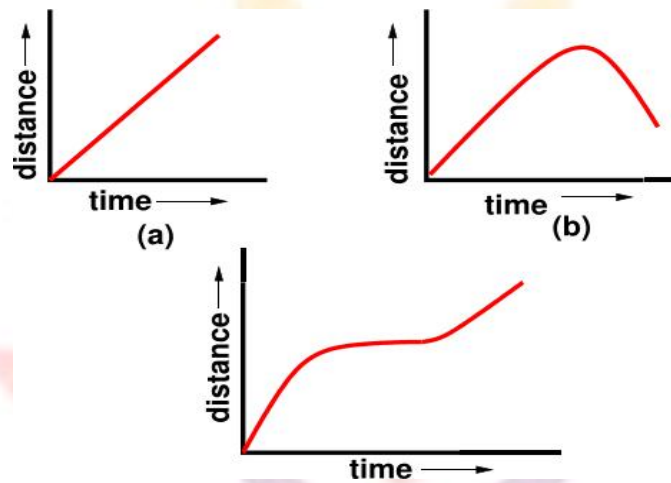

Fig. 11 Single vehicle

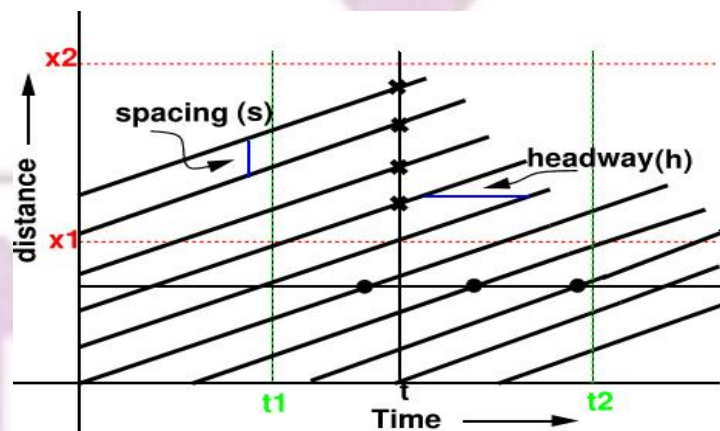

Fig. 12 Many vehicle

FUNDAMENTAL RELATIONS BETWEEN TRAFFIC PARAMETER

Speed is one of the basic parameters of traffic flow and time mean speed and space mean speed are the two representations of speed.

- ✓ Time mean speed (v_t)
- ✓ Space mean speed (v_s)

Fundamental diagrams of traffic flow

The flow and density varies with time and location. The relation between the density and the corresponding flow on a given stretch of road is referred to as one of the fundamental diagram of traffic flow. Some characteristics of an ideal flow-density relationship is listed below:

1. When the density is zero, flow will also be zero, since there is no vehicles on the road.
2. When the number of vehicles gradually increases the density as well as flow increases.
3. When more and more vehicles are added, it reaches a situation where vehicles can't move. This is referred to as the jam density or the maximum density. At jam density, flow will be zero because the vehicles are not moving.
4. There will be some density between zero density and jam density, when the flow is maximum.

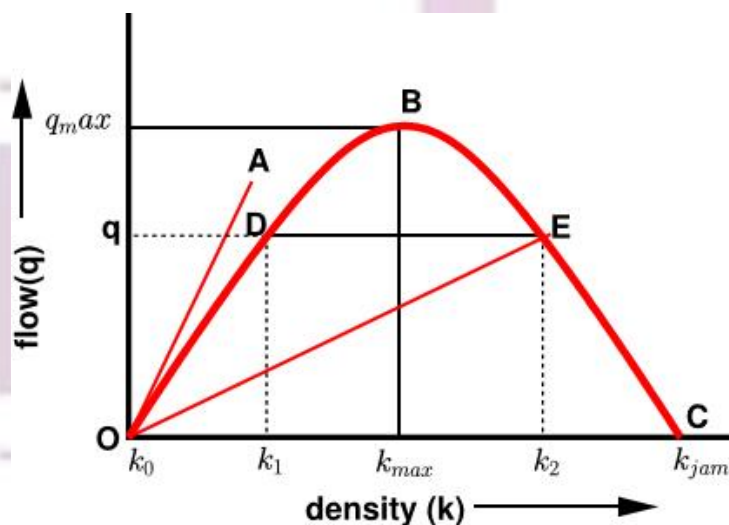

Fig.13 Flow density Curve

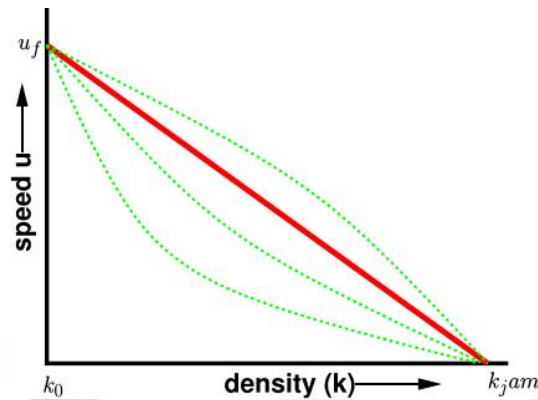

Fig.14 Speed-density diagram

Speed-density diagram

Similar to the flow-density relationship, speed will be maximum, referred to as the free flow speed, and when the density is maximum, the speed will be zero. The most simple assumption is that this variation of speed with density is linear

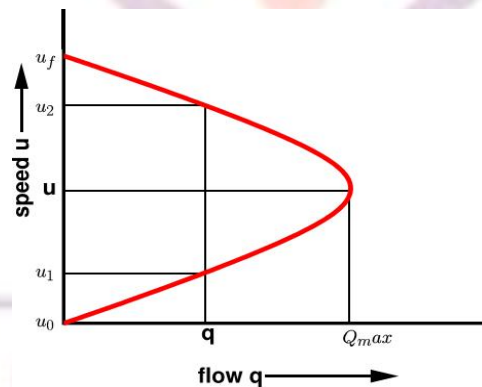

Fig.15 Speed-flow diagram

Data requirements

The measurement procedures can be classified based on the geographical extent of the survey into five categories:

- Measurement at point on the road,
- Measurement over a short section of the road (less than 500 metres)
- Measurement over a length of the road (more than about 500 metres)
- Wide area samples obtained from number of locations, and (e) the use of an observer moving in the traffic stream.

Measurements at a point

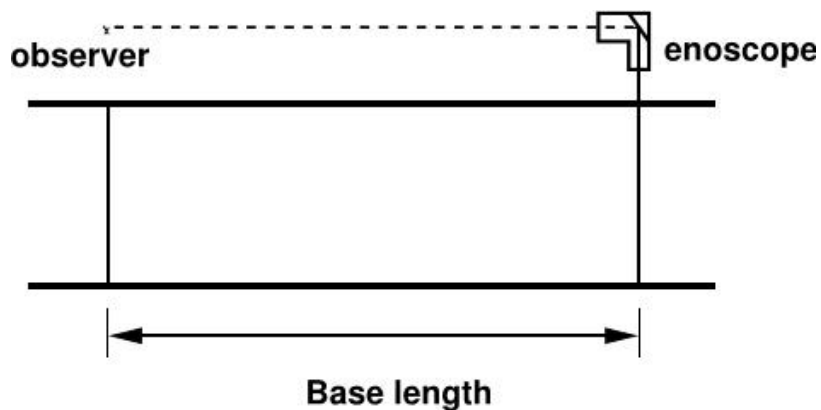

Fig. 16 Illustration of measurement over short section using enoscope

Measurements over short section

The main objective of this study is to find the spot speed of vehicles.

Measurements over long section

This is normally used to obtain variations in speed over a stretch of road.

Moving observer method for stream measurement

Determination of any of the two parameters of the traffic flow will provide the third one by the equation $q = u.k$. Moving observer method is the most commonly used method to get the relationship between the fundamental stream characteristics

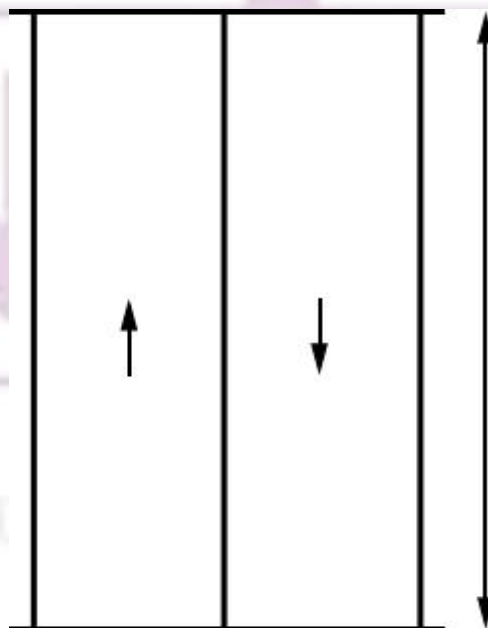

Fig. 17 Illustration of moving observer method



your roots to success...

Capacity

Capacity is defined as the maximum number of vehicles, passengers, or the like, per unit time, which can be accommodated under given conditions with a reasonable expectation of occurrence. Some of the observations that are found from this definition can be now discussed.

Level of service

A term closely related to capacity and often confused with it is service volume. When capacity gives a quantitative measure of traffic, level of service or LOS tries to give a qualitative measure.

Highway capacity

Highway capacity is defined by the Highway Capacity Manual as the maximum hourly rate at which persons or vehicles can be reasonably expected to traverse a point or a uniform segment of a lane or roadway during a given time period under prevailing roadway, traffic and control conditions.

- ✓ Traffic conditions:
- ✓ Road way characteristics:
- ✓ Control conditions:

Factors affecting level of service

Level of service one can derive from a road under different operating characteristics and traffic volumes. The factors affecting level of service (LOS) can be listed as follows:

- Speed and travel time
- Traffic interruptions/restrictions
- Freedom to travel with desired speed
- Driver comfort and convenience
- Operating cost.

Traffic control device is the medium used for communicating between traffic engineer and road users. Unlike other modes of transportation, there is no control on the drivers using the road. Here traffic control devices comes to the help of the traffic engineer. The major types of traffic control devices used are-

1. Traffic signs
2. Road markings
3. Traffic signals
4. Parking control.

Requirements of traffic control devices

The control device should fulfill a need. It should command attention from the road users. It should convey a clear, simple meaning. Road users must respect the signs. The control device should provide adequate time for proper response from the road users.

Types of traffic signs

1. Regulatory signs
2. Warning signs
3. Informative signs

Regulatory signs

These signs are also called mandatory signs because it is mandatory that the drivers must obey these signs. If the driver fails to obey them, the control agency has the right to take legal action against the driver.

- Right of way series
- Speed series
- Movement series
- Parking series
- Pedestrian series
- Miscellaneous

Warning signs

Warning signs or cautionary signs give information to the driver about the impending road condition. They advise the driver to obey the rules.

Informative signs

Informative signs also called guide signs, are provided to assist the drivers to reach their desired destinations. These are predominantly meant for the drivers who are unfamiliar to the place. The guide signs are redundant for the users who are accustomed to the location.



Fig.18 Examples of informative signs

Classification of road markings

The road markings are defined as lines, patterns, words or other devices, except signs, set into applied or attached to the carriageway or kerbs or to objects within or adjacent to the carriageway, for controlling, warning, guiding and informing the users. The road markings are classified as

- Longitudinal markings
- Transverse markings
- Object markings
- Word messages
- Marking for parking
- Marking at hazardous locations

Longitudinal markings

Longitudinal markings are placed along the direction of traffic on the roadway surface, for the purpose of indicating to the driver, his proper position on the roadway.

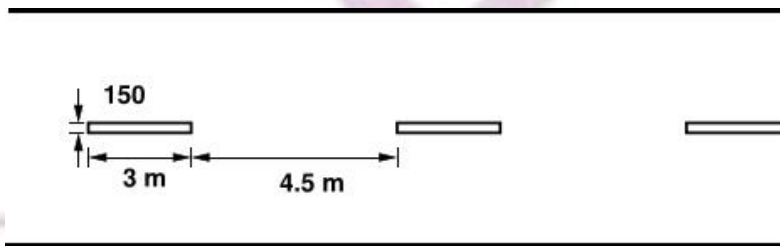

Fig.19 Centre line marking for a two lane road

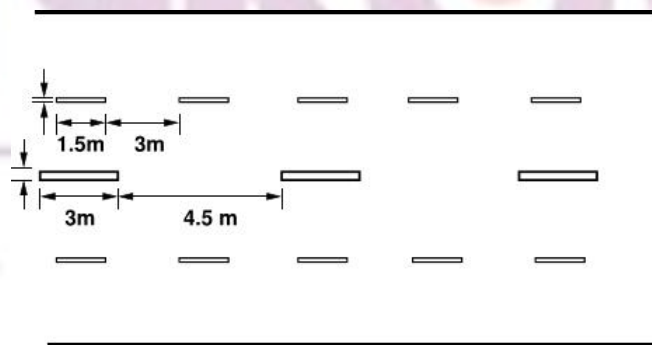

Fig.20 Centre line and lane marking for a four lane road

Centre line

Centre line separates the opposing streams of traffic and facilitates their movements. Usually no centre line is provided for roads having width less than 5 m and for roads having more than four lanes. The centre line may be marked with either single broken line, single solid line, double broken line, or double solid line depending upon the road and traffic requirements.

Traffic lane lines

The subdivision of wide carriageways into separate lanes on either side of the carriage way helps the driver to go straight and also curbs the meandering tendency of the driver.

No passing zones

No passing zones are established on summit curves, horizontal curves, and on two lane and three lane highways where overtaking maneuvers are prohibited because of low sight distance. It may be marked by a solid yellow line along the centre or a double yellow line.

Parking studies

Before taking any measures for the betterment of conditions, data regarding availability of parking space, extent of its usage and parking demand is essential. It is also required to estimate the parking fares also.

- Parking statistics
- Parking accumulation
- Parking volume
- Parking load
- Average parking duration
- Parking turnover
- Parking index

Parking surveys

- In-out survey
- Fixed period sampling
- License plate method of survey

On street parking

- ✓ Parallel parking
- ✓ 30 parking
- ✓ 45 parking
- ✓ 60 parking
- ✓ Right angle parking

Off street

Parking In many urban centres, some areas are exclusively allotted for parking which will be at some distance away from the main stream of traffic. Such a parking is referred to as off-street parking.

TRAFFIC SIGNAL DESIGN

The conflicts arising from movements of traffic in different directions is solved by time sharing of the principle. The advantages of traffic signal includes an orderly movement of traffic, an increased capacity of the intersection and requires only simple geometric design. However the disadvantages of the signalized intersection are it affects larger stopped delays, and the design requires complex considerations.

Definitions and notations

- Cycle
- Cycle length
- Interval
- Green interval
- Red interval
- Phase
- Lost time

Phase design

The signal design procedure involves six major steps They include the

1. phase design
2. determination of amber time and clearance time
3. determination of cycle length
4. apportioning of green time
5. pedestrian crossing requirements,
6. the performance evaluation

Two phase signals

Two phase system is usually adopted if through traffic is significant compared to the turning movements.

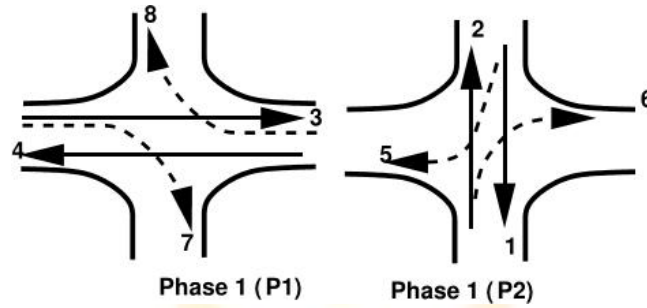

Fig. 21 Two phase signal

Four phase signals

There are at least three possible phasing options.

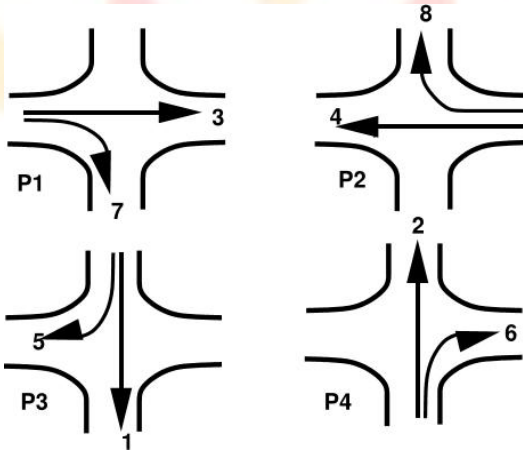

Fig. 21 One way of providing four phase signals

Cycle time

Cycle time is the time taken by a signal to complete one full cycle of iterations. i.e. one complete rotation through all signal indications. It is denoted by C.

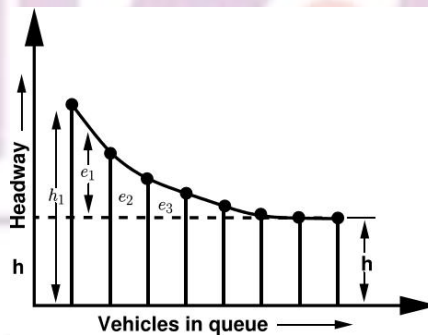

Fig.22 Headways departing signal

UNIT-4

HIGHWAY MATERIALS AND CONSTRUCTION PRACTICES

Sub grade soil

Soil is an accumulation or deposit of earth material, derived naturally from the disintegration of rocks or decay of vegetation, that can be excavated readily with power equipment in the field or disintegrated by gentle mechanical means in the laboratory.

Desirable properties

The desirable properties of sub grade soil as a highway material are

1. Stability
2. Incompressibility
3. Permanency of strength
4. Minimum changes in volume and stability
5. Good drainage
6. Ease of compaction

Soil Classification

Two commonly used systems for soil engineers based on particle distribution and atterberg limits:

- American Association of State Highway and Transportation Officials (AASHTO) System (for state/county highway dept.)
- Unified Soil Classification System (USCS) (preferred by geotechnical engineers).

Soil particles

The description of the grain size distribution of soil particles according to their texture (particle size, shape, and gradation). Major textural classes include, very roughly:

- gravel (>2 mm);
- sand (0.1 – 2 mm);
- silt (0.01 – 0.1 mm);
- clay (< 0.01 mm).

TEST ON SOILS

Sub grade soil is an integral part of the road pavement structure as it provides the support to the pavement from beneath. The main function of the sub grade is to give adequate support to the pavement and for this the sub grade should possess sufficient stability under adverse climatic and loading conditions. Therefore, it is very essential to evaluate the sub grade by conducting tests. The tests used to evaluate the strength properties of soils may be broadly divided into three groups:

1. Shear tests
2. Bearing tests
3. Penetration tests

Shear tests

Shear tests are usually carried out on relatively small soil samples in the laboratory. In order to find out the strength properties of soil, a number of representative samples from different locations are tested. Some of the commonly known shear tests:

- Direct shear test,
- Triaxial compression test,
- Unconfined compression test.

California Bearing Ratio (CBR)

This test was developed by the California Division of Highway as a method of classifying and evaluating soil-sub grade and base course materials for flexible pavements.

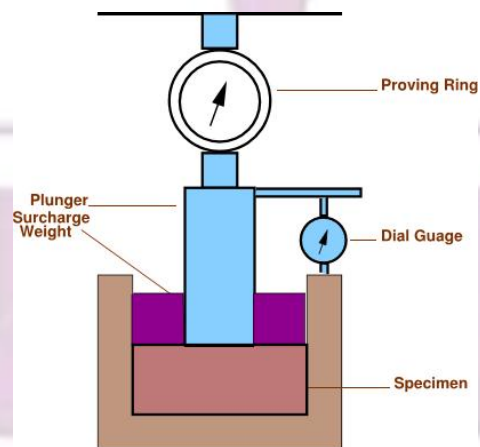

Fig 23 CBR Test

Plate Bearing Test

Plate bearing test is used to evaluate the support capability of sub-grades, bases and in some cases, complete pavement. Data from the tests are applicable for the design of both flexible and rigid pavements. In plate bearing test, a compressive stress is applied to the soil or pavement layer through rigid plates relatively large size and the deflections are measured for various stress values.

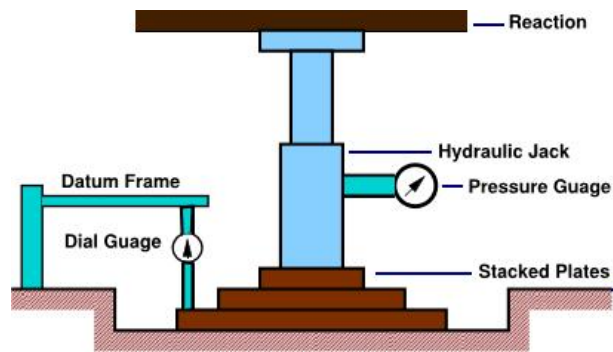

Fig.24 Plate load test

PAVEMENT MATERIALS

Aggregate is a collective term for the mineral materials such as sand, gravel, and crushed stone that are used with a binding medium (such as water, bitumen, Portland cement, lime, etc.) to form compound materials (such as bituminous concrete and Portland cement concrete). By volume, aggregate generally accounts for 92 to 96 percent of Bituminous concrete and about 70 to 80 percent of Portland cement concrete. Aggregate is also used for base and sub-base courses for both flexible and rigid pavements. Aggregates can either be natural or manufactured.

Desirable properties

Strength

The aggregates used in top layers are subjected to

- (i) Stress action due to traffic wheel load,
- (ii) Wear and tear,
- (iii) crushing.

Hardness

The aggregates used in the surface course are subjected to constant rubbing or abrasion due to moving traffic. The aggregates should be hard enough to resist the abrasive action caused by the movements of traffic. The abrasive action is severe when steel tyred vehicles moves over the aggregates exposed at the top surface.

Toughness

Resistance of the aggregates to impact is termed as toughness. Aggregates used in the pavement should be able to resist the effect caused by the jumping of the steel tyred wheels from one particle to another at different levels causes severe impact on the aggregates.

Shape of aggregates

Aggregates which happen to fall in a particular size range may have rounded cubical,

angular, flaky or elongated particles. It is evident that the flaky and elongated particles will have less strength and durability when compared with cubical, angular or rounded particles of the same aggregate. Hence too flaky and too much elongated aggregates should be avoided as far as possible.

Adhesion with bitumen

The aggregates used in bituminous pavements should have less affinity with water when compared with bituminous materials, otherwise the bituminous coating on the aggregate will be stripped off in presence of water.

Durability

The property of aggregates to withstand adverse action of weather is called soundness. The aggregates are subjected to the physical and chemical action of rain and bottom water, impurities there-in and that of atmosphere, hence it is desirable that the road aggregates used in the construction should be sound enough to withstand the weathering action

Freedom from deleterious particles

Specifications for aggregates used in bituminous mixes usually require the aggregates to be clean, tough and durable in nature and free from excess amount of flat or elongated pieces, dust, clay balls and other objectionable material. Similarly aggregates used in Portland cement concrete mixes must be clean and free from deleterious substances such as clay lumps, chert, silt and other organic impurities.

Crushing test

One of the model in which pavement material can fail is by crushing under compressive stress. A test is standardized by IS:2386 part-IV and used to determine the crushing strength of aggregates. The aggregate crushing value provides a relative measure of resistance to crushing under gradually applied crushing load.

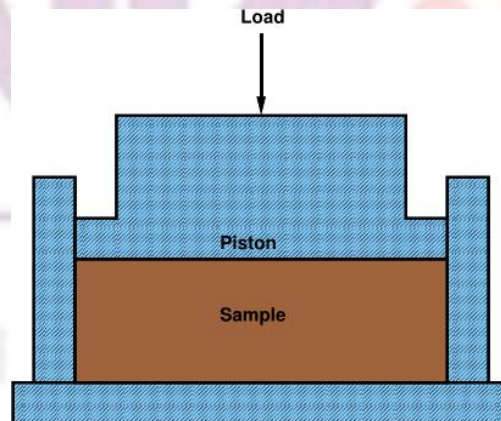

Fig.25 Crushing test setup

Abrasion test

Abrasion test is carried out to test the hardness property of aggregates and to decide whether they are suitable for different pavement construction works. Los Angeles abrasion test is a preferred one for carrying out the hardness property and has been standardized in India (IS:2386 part-IV).

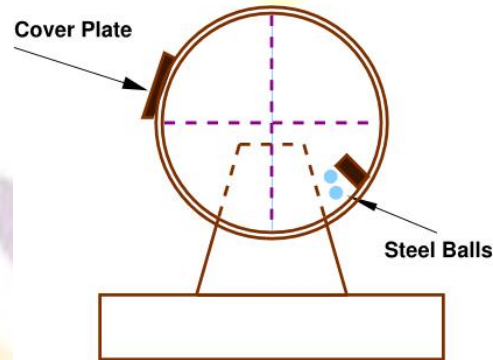

Fig.26 Los Angeles abrasion test setup

Impact test

The aggregate impact test is carried out to evaluate the resistance to impact of aggregates. Aggregates passing 12.5 mm sieve and retained on 10 mm sieve is filled in a cylindrical steel cup of internal dia 10.2 mm and depth 5 cm which is attached to a metal base of impact testing machine. The material is filled in 3 layers where each layer is tamped for 25 number of blows.

Soundness test

Soundness test is intended to study the resistance of aggregates to weathering action, by conducting accelerated weathering test cycles. The Porous aggregates subjected to freezing and thawing are likely to disintegrate prematurely. To ascertain the durability of such aggregates, they are subjected to an accelerated soundness test as specified in IS:2386 part-V.

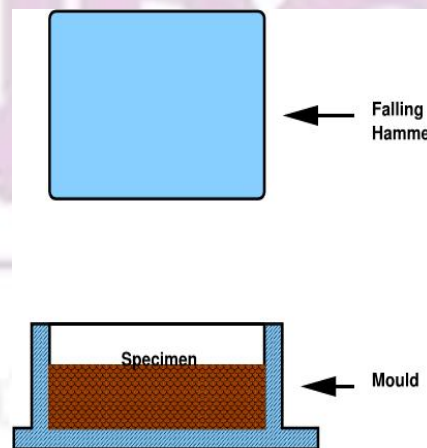

Fig.27 Impact test setup

Shape tests

The particle shape of the aggregate mass is determined by the percentage of flaky and elongated particles in it. Aggregates which are flaky or elongated are detrimental to higher workability and stability of mixes. The flakiness index is defined as the percentage by weight of aggregate particles whose least dimension is less than 0.6 times their mean size. Test procedure had been standardized in India (IS:2386 part-I).

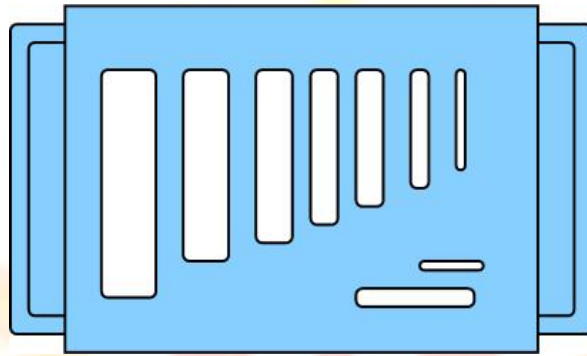

Fig.28 Flakiness gauge

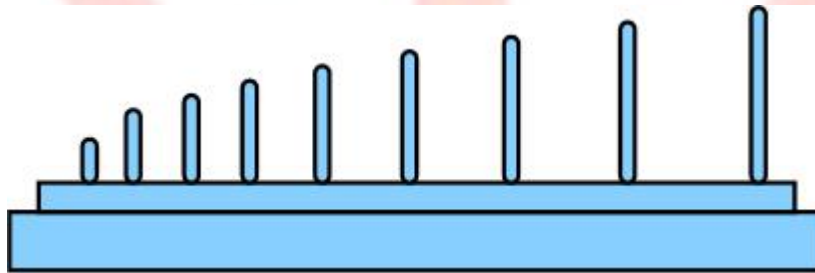

Fig.29 Elongation gauge

Specific Gravity and water absorption

The Specific gravity and water absorption of aggregates are important properties that are required for the design of concrete and bituminous mixes. The Specific gravity of a solid is the ratio of its mass to that of an equal volume of distilled water at a specified temperature.

- Apparent Specific Gravity
- Bulk Specific Gravity

Water absorption, The difference between the apparent and bulk specific gravities is nothing but the water- permeable voids of the aggregates. The specific gravity of aggregates normally used in road construction ranges from about 2.5 to 2.9. Water absorption values ranges from 0.1 to about 2.0 percent for aggregates normally used in road surfacing.

Bitumen adhesion test

Bitumen adheres well to all normal types of road aggregates provided they are dry and free from dust. In the absence of water there is practically no adhesion problem of bituminous construction. Adhesion problem occurs when the aggregate is wet and cold.

Table 24.1 Tests for Aggregates with IS codes

Property of aggregate	Type of Test	Test Method
Crushing strength	Crushing test	IS : 2386 (part 4) -1963
Hardness	Los Angeles abrasion test	IS : 2386 (Part 5)-1963
Toughness	Aggregate impact test	IS : 2386 (Part 4)-1963
Durability	Soundness test- accelerated durability test	IS : 2386 (Part 5)-1963
Shape factors	Shape test	IS : 2386 (Part 1)-1963
Specific gravity and porosity	Specific gravity test and water absorption test	IS : 2386 (Part 3)-1963
Adhesion to bitumen	Stripping value of aggregate	IS : 6241-1971

Production of Bitumen

Bitumen is the residue or by-product when the crude petroleum is refined. A wide variety of refinery processes, such as the straight distillation process, solvent extraction process etc. may be used to produce bitumen of different consistency and other desirable properties.

Vacuum steam distillation of petroleum oils

In the vacuum-steam distillation process the crude oil is heated and is introduced into a large cylindrical still. Steam is introduced into the still to aid in the vaporization of the more volatile constituents of the petroleum and to minimize decomposition of the distillates and residues. The volatile constituents are collected, condensed, and the various fractions stored for further refining, if needed. The residues from this distillation are then fed into a vacuum distillation unit, where residue pressure and steam will further separate out heavier gas oils. The bottom fraction from this unit is the vacuum-steam-refined asphalt cement.

Different forms of bitumen

Cutback bitumen

Normal practice is to heat bitumen to reduce its viscosity. In some situations preference is given to use liquid binders such as cutback bitumen. In cutback bitumen suitable solvent is used to lower the viscosity of the bitumen. From the environmental point of view also cutback bitumen is preferred.

There are different types of cutback bitumen like rapid curing (RC), medium curing (MC), and slow curing (SC).

Bitumen emulsion

Bitumen emulsion is a liquid product in which bitumen is suspended in a finely divided condition in an aqueous medium and stabilized by suitable material. Three types of bituminous emulsions are available, which are Rapid setting (RS), Medium setting (MS), and Slow setting (SC). Bitumen emulsions are ideal binders for hill road construction.

Bituminous primers

In bituminous primer the distillate is absorbed by the road surface on which it is spread. The absorption therefore depends on the porosity of the surface. Bitumen primers are useful on the stabilized surfaces and water bound macadam base courses. Bituminous primers are generally prepared on road sites by mixing penetration bitumen with petroleum distillate.

Modified Bitumen

Certain additives or blend of additives called as bitumen modifiers can improve properties of Bitumen and bituminous mixes. Bitumen treated with these modifiers is known as modified bitumen. Polymer modified bitumen (PMB)/ crumb rubber modified bitumen (CRMB) should be used only in wearing course depending upon the requirements of extreme climatic variations. The detailed specifications for modified bitumen have been issued by IRC: SP: 53-1999.

Requirements of Bitumen

The desirable properties of bitumen depend on the mix type and construction. In general, Bitumen should possess following desirable properties.

- The bitumen should not be highly temperature susceptible: during the hottest weather the mix should not become too soft or unstable, and during cold weather the mix should not become too brittle causing cracks.
- The viscosity of the bitumen at the time of mixing and compaction should be adequate. This can be achieved by use of cutbacks or emulsions of suitable grades or by heating the bitumen and aggregates prior to mixing.
- There should be adequate affinity and adhesion between the bitumen and aggregates used in the mix.

Tests on bitumen

There are a number of tests to assess the properties of bituminous materials. The following tests are usually conducted to evaluate different properties of bituminous materials.

- Penetration test
- Ductility test
- Softening point test

- Specific gravity test
- Viscosity test
- Flash and Fire point test
- Float test
- Water content test
- Loss on heating test

Penetration test

It measures the hardness or softness of bitumen by measuring the depth in tenths of a millimeter to which a standard loaded needle will penetrate vertically in 5 seconds. BIS had standardized the equipment and test procedure. The penetrometer consists of a needle assembly with a total weight of 100g and a device for releasing and locking in any position.

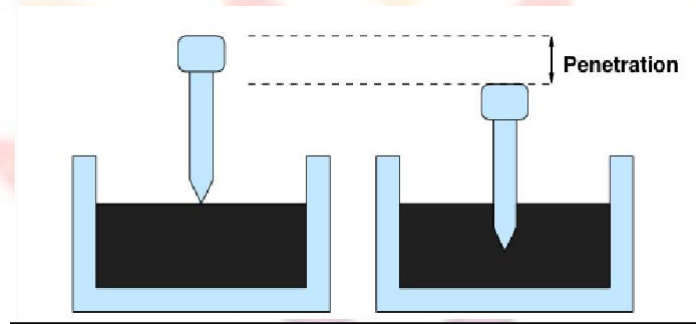

Fig. 30 Penetration Test Setup

Ductility test

Ductility is the property of bitumen that permits it to undergo great deformation or elongation. Ductility is defined as the distance in cm, to which a standard sample or briquette of the material will be elongated without breaking.

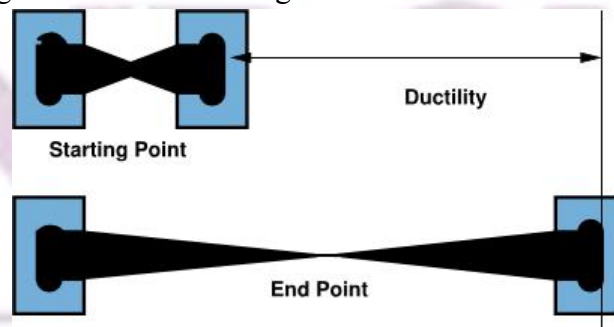

Fig. 31 Ductility Moulds

Softening point test

Softening point denotes the temperature at which the bitumen attains a particular degree of softening under the specifications of test. The test is conducted by using Ring and Ball apparatus.

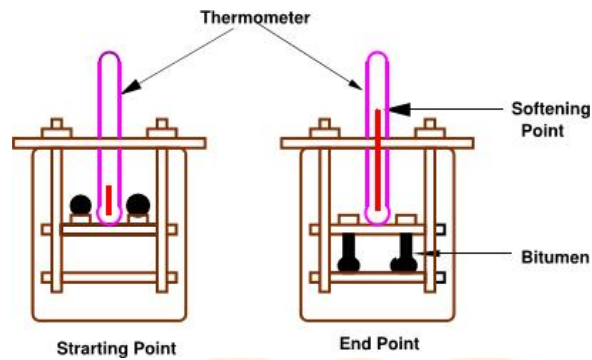

Fig. 32 Softening Point Test Setup

Specific gravity test

In paving jobs, to classify a binder, density property is of great use. In most cases bitumen is weighed, but when used with aggregates, the bitumen is converted to volume using density values. The density of bitumen is greatly influenced by its chemical composition. Increase in aromatic type mineral impurities cause an increase in specific gravity.

Viscosity test

Viscosity denotes the fluid property of bituminous material and it is a measure of resistance to flow. At the application temperature, this characteristic greatly influences the strength of resulting paving mixes. Low or high viscosity during compaction or mixing has been observed to result in lower stability values. At high viscosity, it resist the compactive effort and thereby resulting mix is heterogeneous, hence low stability values.

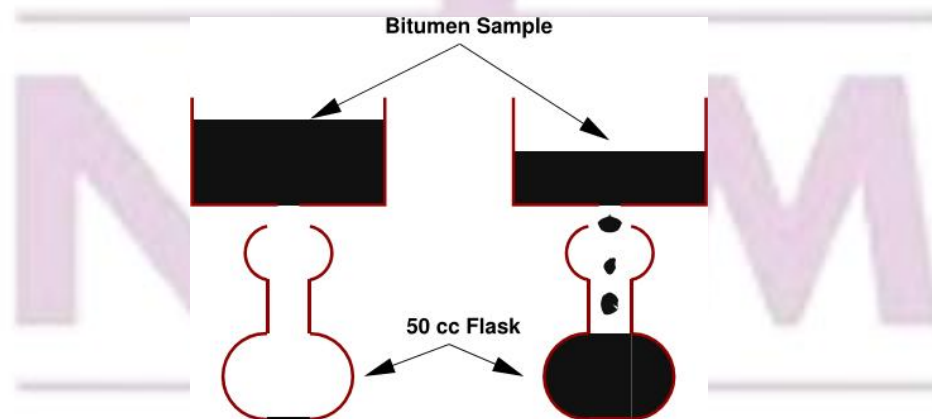

Fig.33 Viscosity apparatus

Flash and fire point test

At high temperatures depending upon the grades of bitumen materials leave out volatiles. And these volatiles catches fire which is very hazardous and therefore it is essential to qualify

this temperature for each bitumen grade.

Float test

Normally the consistency of bituminous material can be measured either by penetration test or viscosity test. But for certain range of consistencies, these tests are not applicable and Float test is used.

Water content test

It is desirable that the bitumen contains minimum water content to prevent foaming of the bitumen when it is heated above the boiling point of water. The water in a bitumen is determined by mixing known weight of specimen in a pure petroleum distillate free from water, heating and distilling of the water.

Loss on heating test

When the bitumen is heated it loses the volatility and gets hardened. About 50gm of the sample is weighed and heated to a temperature of 163 C for 5 hours in a specified oven designed for this test.

Objectives of mix design

1. Sufficient bitumen to ensure a durable pavement,
2. Sufficient strength to resist shear deformation under traffic at higher temperature,
3. Sufficient air voids in the compacted bitumen to allow for additional compaction by traffic,
4. Sufficient workability to permit easy placement without segregation,
5. Sufficient flexibility to avoid premature cracking due to repeated bending by traffic, and
6. Sufficient flexibility at low temperature to prevent shrinkage cracks.

Constituents of a mix

- Coarse aggregates
- Fine aggregates
- Filler
- Binder

Types of mix

- Well-graded mix
- Gap-graded mix

- Open-graded mix
- Unbounded

Different layers in a pavement

- Bituminous base course
- Bituminous binder course
- Asphaltic/Bituminous concrete.

Stability

Stability is defined as the resistance of the paving mix to deformation under traffic load. Two examples of failure are

- (i) shoving - a transverse rigid deformation which occurs at areas subject to severe acceleration
- (ii) grooving - longitudinal ridging due to channelization of traffic. Stability depend on the inter-particle friction, primarily of the aggregates and the cohesion offered by the bitumen.

Durability

Durability is defined as the resistance of the mix against weathering and abrasive actions.

- (i) pot-holes, - deterioration of pavements locally and
- (ii) stripping, lost of binder from the aggregates and aggregates are exposed.

Flexibility

Flexibility is a measure of the level of bending strength needed to counteract traffic load and prevent cracking of surface. Fracture is the cracks formed on the surface (hairline-cracks, alligator cracks), main reasons are shrinkage and brittleness of the binder.

Skid resistance

It is the resistance of the finished pavement against skidding which depends on the surface texture and bitumen content. It is an important factor in high speed traffic.

Workability

Workability is the ease with which the mix can be laid and compacted, and formed to the required condition and shape.

Desirable properties

From the above discussion, the desirable properties of a bituminous mix can be summarized as follows:

- ✓ Stability to meet traffic demand
- ✓ Bitumen content to ensure proper binding and water proofing

- ✓ Voids to accommodate compaction due to traffic
- ✓ Flexibility to meet traffic loads, esp. in cold season
- ✓ Sufficient workability for construction • Economical mix

Selection of aggregates

The desirable qualities of a bituminous paving mixture are dependent to a considerable degree on the nature of the aggregates used. Aggregates are classified as coarse, fine, and filler. The function of the coarse aggregates in contributing to the stability of a bituminous paving mixture is largely due to interlocking and frictional resistance of adjacent particles.

Aggregate gradation

The properties of the bituminous mix including the density and stability are very much dependent on the aggregates and their grain size distribution.

However, some minimum amount of void space is necessary to:

- provide adequate volume for the binder to occupy,
- promote rapid drainage, and
- provide resistance to frost action for base and sub base courses.

Proportioning of aggregates

After selecting the aggregates and their gradation, proportioning of aggregates has to be done and following are the common methods of proportioning of aggregates:

- Trial and error procedure:
- Graphical Methods:
- Analytical Method:

Marshall mix design

The Marshall stability and flow test provides the performance prediction measure for the Marshall mix design method. The stability portion of the test measures the maximum load supported by the test specimen at a loading rate of 50.8 mm/minute.

Specimen preparation

Determine the properties of the mix

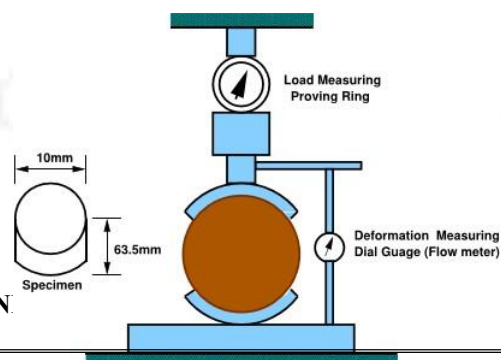

Fig. 34 Marshall Mould

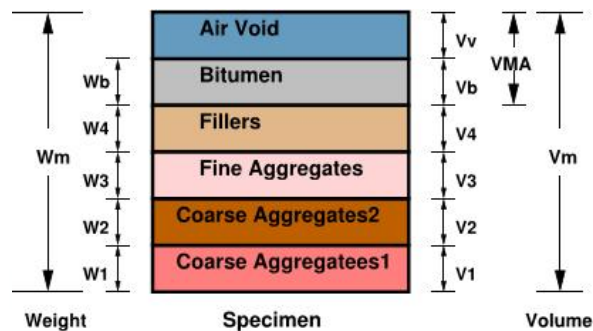

Fig. 35 Marshall Mould

Theoretical specific gravity of the mix G_t

$$G_t = \frac{W_1 + W_2 + W_3 + W_b}{\frac{W_1}{G_1} + \frac{W_2}{G_2} + \frac{W_3}{G_3} + \frac{W_b}{G_b}}$$

Bulk specific gravity of mix G_m

$$G_m = \frac{W_m}{W_m - W_w}$$

Air voids percent V_v

$$V_b = \frac{\frac{W_b}{G_b}}{\frac{W_1 + W_2 + W_3 + W_b}{G_m}}$$

Voids in mineral aggregate $VMA = V_v + V_b$

Determine Marshall stability and flow

Marshall stability of a test specimen is the maximum load required to produce failure when the specimen is preheated to a prescribed temperature placed in a special test head and the load is applied at a constant strain (5 cm per minute).

Apply stability correction

Volume of specimen (cm ³)	Thickness of specimen (mm)	Correction Factor
457 - 470	57.1	1.19
471 - 482	68.7	1.14
483 - 495	60.3	1.09
496 - 508	61.9	1.04
509 - 522	63.5	1.00
523 - 535	65.1	0.96
536 - 546	66.7	0.93
547 - 559	68.3	0.89
560 - 573	69.9	0.86

Prepare graphical plots

The average value of the above properties are determined for each mix with different bitumen content and the following graphical plots are prepared:

1. Binder content versus corrected Marshall stability
2. Binder content versus Marshall flow
3. Binder content versus percentage of void in the total mix v
4. Binder content versus voids filled with bitumen (V F B)
5. Binder content versus unit weight or bulk specific gravity

Determine optimum bitumen content

Determine the optimum binder content for the mix design by taking average value of the following three bitumen contents found from the graphs obtained in the previous step.

1. Binder content corresponding to maximum stability
2. Binder content corresponding to maximum bulk specific gravity
3. Binder content corresponding to the median of designed limits of percent air voids in the total mix v (i.e. 4%)

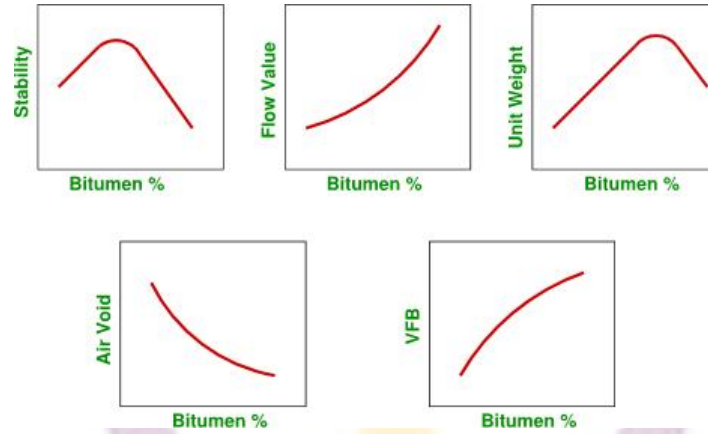

Fig. 36 Marshal graphical plots



your roots to success...

UNIT-5

PAVEMENT DESIGN

Flexible pavements are so named because the total pavement structure deflects, or flexes, under loading. A flexible pavement structure is typically composed of several layers of materials. Each layer receives loads from the above layer, spreads them out, and passes on these loads to the next layer below. Thus the stresses will be reduced, which are maximum at the top layer and minimum on the top of subgrade.

Design procedures

- Empirical design
- Empirical design

Traffic and Loading

- Fixed traffic
- Fixed vehicle
- Variable traffic and vehicle

Equivalent single wheel load

To carry maximum load within the specified limit and to carry greater load, dual wheel, or dual tandem assembly is often used. Equivalent single wheel load (ESWL) is the single wheel load having the same contact pressure, which produces same value of maximum stress, deflection, tensile stress or contact pressure at the desired depth.

Equivalent single wheel load To carry maximum load within the specified limit and to carry greater load, dual wheel, or dual tandem assembly is often used. Equivalent single wheel load (ESWL) is the single wheel load having the same contact pressure, which produces same value of maximum stress, deflection, tensile stress or contact pressure at the desired depth.

$$\log_{10} ESWL = \log_{10} P + \frac{0.301 \log_{10} \left(\frac{z}{d/2} \right)}{\log_{10} \left(\frac{2S}{d/2} \right)}$$

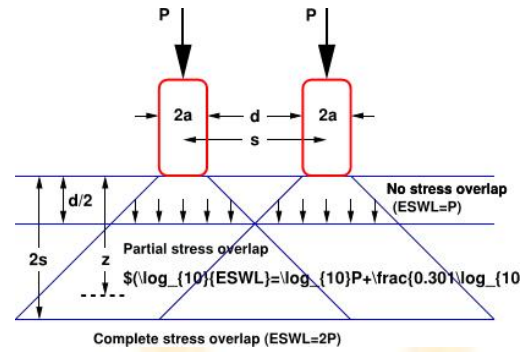

Fig. 37 ESWL-Equal stress concept

Equivalent single axle load

- Legal axle load
- Standard axle load

Repetition of axle loads

Equivalent axle load factor

$$\text{Equivalent single axle load, ESAL} = \sum_{i=1}^m F_i n_i$$

Material characterization

It is well known that the pavement materials are not perfectly elastic but experiences some permanent deformation after each load repetitions. It is well known that most paving materials are not elastic but experience some permanent deformation after each load application.

Resilient modulus of soil

The elastic modulus based on the recoverable strain under repeated loads is called the resilient modulus.

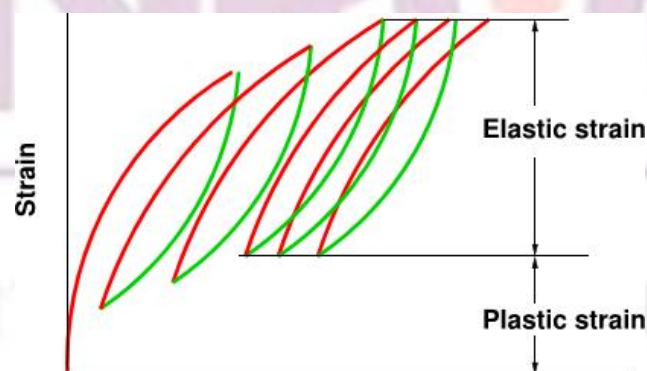

Fig. 38 Recoverable strain under repeated loads

Dynamic complex modulus

This is one of the way of explaining the stress-strain relationship of visco-elastic materials.

Correlations with other tests

Determination of resilient modulus is often cumbersome. Therefore, various empirical tests have been used to determine the material properties for pavement design.

Mechanistic-empirical analysis

Mechanics is the science of motion and action of forces on bodies. In pavement design these phenomena are stresses, strains, and deflections within a pavement structure and the physical causes are loads and material properties of the pavements structure.

Advantages

The basic advantages of the Mechanistic-Empirical pavement design method over a purely empirical one are:

- It can be used for both existing pavement rehabilitation and new pavement construction
- It can accommodate changing load types
- It can better characterize materials allowing for better utilization of available materials accommodation of new materials improved definition of existing layer proportion
- It uses material proportion that relates better with actual pavement performance
- It provides more reliable performance predictions
- It defines role of construction in a better way
- It accommodates environment and aging effect of materials in the pavement

Mechanistic model

Mechanistic models are used to mathematically model pavement physics.

Inputs

A layered elastic model requires a minimum number of inputs to adequately characterize a pavement structure and its response to loading. These inputs are:

Material properties of each layer, like modulus of elasticity (E), Poisson's ratio, Pavement layer thicknesses, and Loading conditions which include the total wheel load and load repetitions

Output

The outputs of the layered elastic model are the stresses, strains and deflections in the pavements.

- Stress.
- Strain.
- Deflection.

IRC Method of Flexible Pavement Design

Scope

These guidelines will apply to design of flexible pavements for Expressway, National Highways, State Highways, Major District Roads, and other categories of roads. Flexible pavements are considered to include the pavements which have bituminous surfacing and granular base and sub-base courses conforming to IRC/ MOST standards. These guidelines apply to new pavements.

Design criteria

- Vertical compressive strain at the top of the sub-grade which can cause sub-grade deformation resulting in permanent deformation at the pavement surface.
- Horizontal tensile strain or stress at the bottom of the bituminous layer which can cause fracture of the bituminous layer.
- Pavement deformation within the bituminous layer.

Failure Criteria

- Fatigue Criteria
- Rutting Criteria



Fig. 39 Critical Locations in Pavement

Design procedure

Based on the performance of existing designs and using analytical approach, simple design charts and a catalogue of pavement designs are added in the code.

Using the following simple input parameters, appropriate designs could be chosen for the given traffic and soil strength:

- Design traffic in terms of cumulative number of standard axles; and
- CBR value of subgrade.

Design traffic

The method considers traffic in terms of the cumulative number of standard axles (8160 kg) to be carried by the pavement during the design life. This requires the following information:

- Initial traffic in terms of CVPD
- Traffic growth rate during the design life
- Design life in number of years
- Vehicle damage factor (VDF)
- Distribution of commercial traffic over the carriage way.

Pavement thickness design charts

For the design of pavements to carry traffic in the range of 1 to 10 msa, use chart 1 and for traffic in the range 10 to 150 msa, use chart 2 of IRC:37 2001.

Pavement composition

- Sub-base
- Base
- Bituminous surfacing

STRESSES IN RIGID PAVEMENTS

As the name implies, rigid pavements are rigid i.e, they do not flex much under loading like flexible pavements. They are constructed using cement concrete. In this case, the load carrying capacity is mainly due to the rigidity and high modulus of elasticity of the slab (slab action).

Modulus of sub-grade reaction

Westergaard considered the rigid pavement slab as a thin elastic plate resting on soil sub-grade, which is assumed as a dense liquid. The upward reaction is assumed to be proportional to the deflection.

Relative stiffness of slab to sub-grade

A certain degree of resistance to slab deflection is offered by the sub-grade. The sub-grade

deformation is same as the slab deflection. Hence the slab deflection is direct measurement of the magnitude of the sub-grade pressure.

Critical load positions

There are three typical locations namely the interior, edge and corner, where differing conditions of slab continuity exist. These locations are termed as critical load positions.

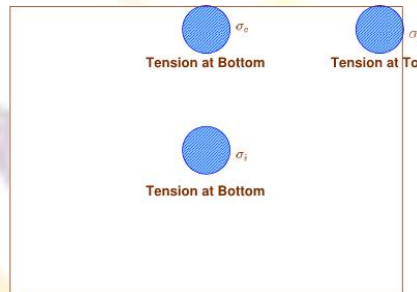

Fig. 40 Critical stress locations

Temperature stresses

Temperature stresses are developed in cement concrete pavement due to variation in slab temperature. This is caused by

- (i) Daily variation resulting in a temperature gradient across the thickness of the slab and
- (ii) Seasonal variation resulting in overall change in the slab temperature.

Combination of stresses

The cumulative effect of the different stress give rise to the following thee critical cases

- Summer, mid-day: The critical stress is for edge region
- Winter, mid-day: The critical combination of stress is for the edge region given by
- Mid-nights: The critical combination of stress is for the corner region given

Expansion joints

The purpose of the expansion joint is to allow the expansion of the pavement due to rise in temperature with respect to construction temperature.

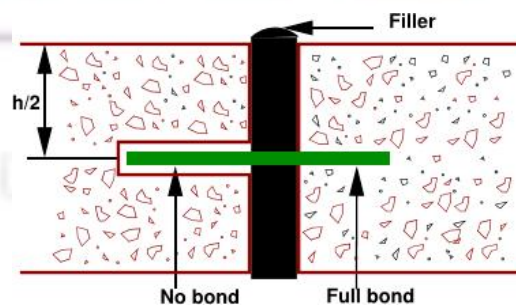
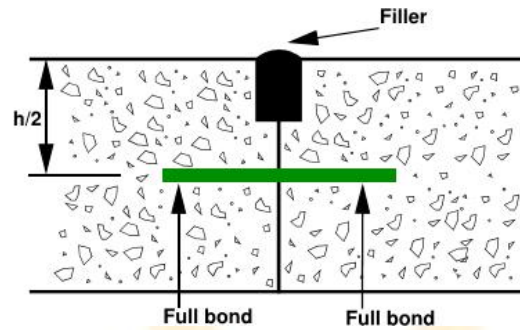

Fig. 41 Expansion joint

Contraction joints



42 Contraction Joint

Dowel bars

The purpose of the dowel bar is to effectively transfer the load between two concrete slabs and to keep the two slabs in same height.

Tie bars

In contrast to dowel bars, tie bars are not load transfer devices, but serve as a means to tie two slabs. Hence tie bars must be deformed or hooked and must be firmly anchored into the concrete to function properly.

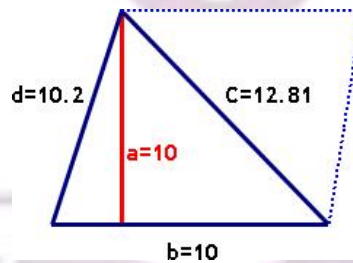

$$\text{Triangle area } A = a * b/2$$

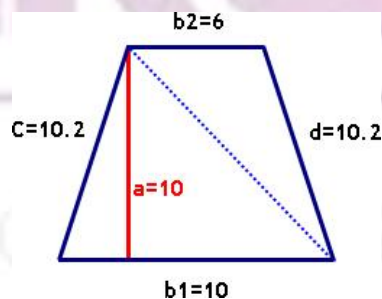



your roots to success...